



New Products 2022



Content

Digimar Overview	4
Height Measuring Instruments	
Digimar 817 CLT	6
Height Measuring Instrument	
Digimar Accessories	7
Millimes Overview	14
Comparators	
Millimes 2000 W / 2000 Wi	16
Inductive Comparators	
Millimes 2001 W / 2001 Wi	18
Inductive Comparators	
Mar4D PLQ	22
Cylinder Coordinate Measuring Machines	
Mar4D PLQ 4200	24
Cylinder Coordinate Measuring Machine	
MarSurf Overview	26
Contour Measuring Instruments	
MarSurf CD 140 AG 11	28
Contour Measuring Station	
Reference Form Tester Overview	30
Form Measuring Instruments and Measuring Instruments for the Optical Industry	
MarForm MFU 200	32
Reference Form Measuring Station	
MarOpto MFU 200-3D	34
Precision 3D Measuring Station	

Digimar 817 CLT: Easy measurements using intuitive touch control



Best connection for secure data

Data can be transferred wirelessly or via USB cable via the MarConnect interface. Quickly print out a series of measurements? A Bluetooth printer is available for this purpose. Simply choose between complete measuring records in PDF format or save your measuring records as a TXT file.



Interfaces for dial indicators

An interface integrated in the slide enables the error-free measurement of the perpendicularity and straightness using the new Millimes 2000/2001W dial comparators.



Ergonomics that can be measured

Ergonomics means that the methods, processes, and arrangement are designed for people and not the other way around. This is exactly what the new Digimar 817 CLT stands for: The simple moving and scrolling functions of the touchscreen work just like smartphone and tablet. The keys on the display are already arranged in such a way that frequently used functions are particularly easy to access. The measurements on the measuring slide can easily be started by hand via the touch display, the thumbwheel with integrated arrow keys, or using Quick mode. Two pushbuttons to actuate the air bearings are integrated into the handle enabling the device to be guided safely and sensitively by left- and right-handed operators. Regardless of whether you prefer to sit or stand while working: The touch display is always at eye level and can be rotated and tilted as required. This ensures the measuring process is particularly comfortable and relaxed.





Simple touch measurement

Intuitive operation via large, clearly defined keys to ensure the safe completion on measurements, setting and calculation of functions, and the creation of measuring programs via Drag & Drop.

Pivoting display

10-inch touch panel with turn/tilt joint so that it can be set individually for the work position, height of the operator, and lighting conditions.



Easy handling

The thumbwheel can be used to move the measuring slide quickly and easily start the measurement. The quick measurement function keys also automatically detect surfaces and bores.



Best ergonomics

Ergonomic handles on both sides have an integrated operating key for the air bearing ensuring the device can be moved accurately and effortlessly on the measuring plate.



Digimar 817 CLT

Height measuring instrument



FEATURES

Operating and display unit

- Large and clearly defined touch display with backlighting
- Operator guidance with self-explanatory icons
- Multilingual user guidance
- Option of setting additional zero points on the workpiece
- Additional measuring instrument can be connected via MarConnect USB port
- Future-proof thanks to software updates
- Automatic activation of standby mode
- Selectable auto-off function, without loss of measured values



Functions

- Top or bottom contacting
- Web width or distances between grooves, including center of web or groove
- Bore or shaft diameter, including center of bore or shaft
- Bore reversing point (up or down)
- Shaft reversing point (up or down)
- Calculating distances or symmetry
- Dynamic measuring functions
- Perpendicularity measurement
- Straightness measurement
- Measurement in 2D mode
- Measuring programs
- Measuring data processing

Measuring system

- Optical incremental measuring system for outstanding measuring accuracy and reliability
- Dynamic probe system enabling high repeatability
- Air bearing system for light and smooth movement
- Motorized measuring slide simplifies measurement runs
- Probe constant remains after the instrument is switched off
- Integrated rechargeable battery with a long operating life for mains-independent measurement
- Temperature compensation via internal temperature sensor

Scope of delivery

- Height measuring instrument incl. operating and display element
- Carrier 817 h1
- Measuring anvil K6/51
- Setting gage 817 eb
- USB cable
- Operating instructions
- Recharging unit
- Protective cover
- Calibration certificate

TECHNICAL DATA

Order no.	4429600	4429601	4429602
Product type		817 CLT	
Measuring range	mm 0 – 350	0 – 600	0 – 1000
Application range from	mm	170	
Application range up to	mm 520	770	1170
Resolution	mm	0.01, 0.005, 0.001, 0.0005, 0.0001	
Resolution	inch	.001", .0005", .0001", .00005", .00001"	
Error limit	µm	(1.8 + L/600) L in mm	
Repeatability bores	µm	1	
Repeatability planes	µm	0.5	
Perpendicularity error in µm	µm	5	6 10
Operating time max.	h	14	
Measuring force	N	1.0 +/- 0.2 N	
Relative humidity non-condensing	%	65	
Working temperature	°C	20	
Operating temperature	°C	10 – 40	
Product weight	kg	22	26 29
Data interface		USB, Wireless	
Standard		Factory standard	

ACCESSORIES

Order no.	Product name	Product type
6910271	Printer set incl. Bluetooth USB adapter	DP-B1
4102220	USB adapter for MarConnect Wireless	i-stick
4221525	Surface plate made from granite, 1000 x 630 mm	107 G
5450105	Printer paper, 12 rolls	
4221573	Stand, 1000 x 630 mm	107 Ug
4221526	Surface plate made from granite, 1200 x 800 mm	107 G
4221574	Stand, 1200 x 800 mm	107 Ug

Software

- MarCom Professional can be downloaded free of charge from: www.mahr.com/marcom (only for Mahr data cable and wireless systems with USB and RS-232 interface)



i-Stick



107 G + 107 Ug



DP-B1

Digimar 817 ts1

Probe set

FEATURES

- Large accessory kit
- Packaged in a practical plastic case
- Consisting of:
 - Depth probe
 - Carrier with extended holder
 - Disc measuring probe for grooves, etc.
 - Conical measuring probe
 - Cylindrical measuring probe
 - Holder for test indicator styli with M2 thread
 - Carrier including 4 spherical probes with shaft diameter 8 mm
- Package contains: case



TECHNICAL DATA

Order no.	Product type
4429019	817 ts1

COMPONENTS INCLUDED IN SET

Order no.	Product name	Product type
4429219	Carrier for a probe, mounting hole 6 mm, a = 100.5 mm, b = 119.5 mm, c = 84 mm	817 h2
4429226	Disc probe \varnothing 15 mm	S 15/31.2
4429227	Cylindrical probe \varnothing 10 mm	Z 10/31.2
4429228	Taper probe	MKe 30
4429221	Depth probe incl. Holder	TMT 120
4429256	Probe with M2 threads for 3 styli positions ($0^\circ/10^\circ/90^\circ$), incl. styli 800 ts \varnothing 2.0 mm	KM 2
4429220	Carrier for probes 817 CLM, mounting hole 8 mm	817 h4
7023813	Probe with mount, \varnothing 4.0 mm	K 4/30
7023816	Probes with mount, \varnothing 6 mm	K 6/40
7023810	Probes with mount, \varnothing 10.0 mm	K 10/60
7023615	Probes with mount, \varnothing 10.0 mm	K 10/100

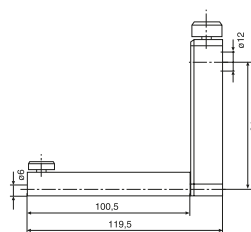

817 h2

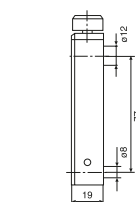

817 h4

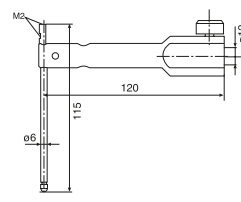

TMT 120

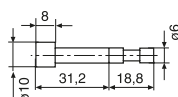

Z 10/31.2

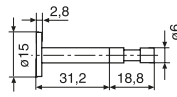

S 15/31.2

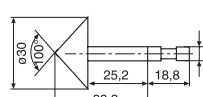

MKe 30

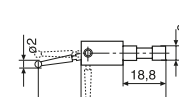

KM 2

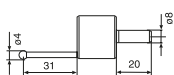

K 4/30

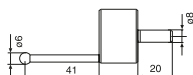

K 6/40

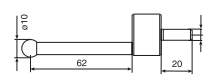

K 10/60

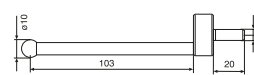

K 10/100

Digimar 817 ts2

Probe set

FEATURES

- Small accessory kit
- Packaged in a practical plastic case
- Consisting of:
 - Depth probe
 - Carrier with extended holder
 - Disc measuring probe for grooves, etc.
 - Conical measuring probe
 - Cylindrical measuring probe
 - Holder for test indicator styli with M2 thread
- Package contains: case



TECHNICAL DATA

Order no.	Product type
4429018	817 ts2

COMPONENTS INCLUDED IN SET

Order no.	Product name	Product type
4429219	Probe carrier, mounting hole 6 mm, a = 100.5 mm, b = 119.5 mm, c = 84 mm	817 h2
4429226	Disc probe \varnothing 15 mm	S 15/31.2
4429227	Cylindrical probe \varnothing 10 mm	Z 10/31.2
4429228	Taper probe	MKe 30
4429221	Depth probe including holder	TMT 120
4429256	Probe incl. styli 800 ts \varnothing 2.0 mm	KM 2

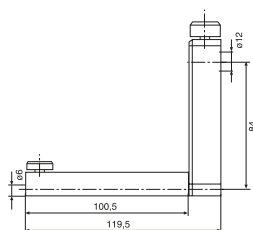

817 h2

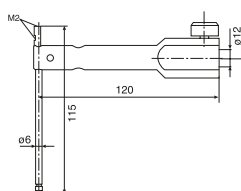

TMT 120

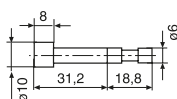

Z 10/31.2

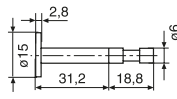

S 15/31.2

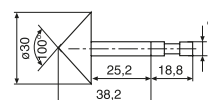

MKe 30

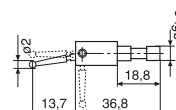

KM 2

Digimar 817 ts3

Universal probe set

FEATURES

- Accessory kit for small parts and delicate grooves, recesses and bores
- Packaged in a practical wooden case
- Suitable for 817 h4 carriers with 8 mm mounting bore
- Consisting of:
 - Base with 8 mm holding shaft
 - Depth probe
 - Probe shoe for grooves and recesses
 - Spherical measuring probe
 - Conical measuring probe
 - Extension
 - Adapter for M2.5 measuring anvils
- Package contains: case



TECHNICAL DATA

Order no.	Product type
7034000	817 ts3

COMPONENTS INCLUDED IN SET

Order no.	Product name	Product type
3015917	Probe carrier	GK/8
3015918	Measuring crook, $d = 0.5 \text{ mm}$, $l = 78 \text{ mm}$	TS 0.5/78
3015919	Probe pin/tip, $d = 1.2 \text{ mm}$, $l = 75 \text{ mm}$, $l_s = 15.5 \text{ mm}$	T 1.2/75
3015920	Taper probe	MKe 8
3022000	Spherical probe, $d_k = 3.0 \text{ mm}$, $l = 24 \text{ mm}$	K 3/24
3022001	Spherical probe, $d_k = 2.0 \text{ mm}$, $l = 24 \text{ mm}$	K 2/24
3022002	Spherical probe, $d_k = 1.0 \text{ mm}$, $l = 24 \text{ mm}$	K 1/24
3015888	Extension M3 - M2.5, $d = 4 \text{ mm}$, $l = 20 \text{ mm}$	V/M 2.5
3015921	Extension M3 - M3, $d = 4 \text{ mm}$, $l = 20 \text{ mm}$	V/M 3

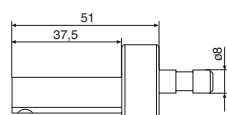

GK/8

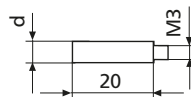

V/M2...M3

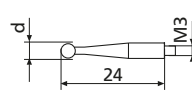

K 1...K3/24

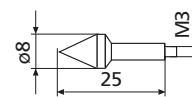

Mke 8

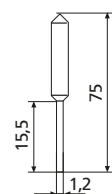

T 1.2/75

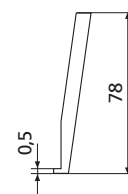

TS 0.5/78

Digimar 817 h1 / 817 h2 / 817 h5

Probe carriers

FEATURES

- Carrier for probes with 6 mm holding shaft
- Used for measurements at increased measuring depth (817 h2)
- Pivoting (817 h5) e.g. for aligning a cylindrical measuring probe



TECHNICAL DATA

Order no.	Product type
4429154	817 h1
4429219	817 h2
4429454	817 h5

Order no.	a	b	c	Mounting hole
	mm	mm	mm	
4429154	27.5	46.5	84	6 mm
4429219	100.5	119.5	84	6 mm
4429454	35	54	86	6 mm

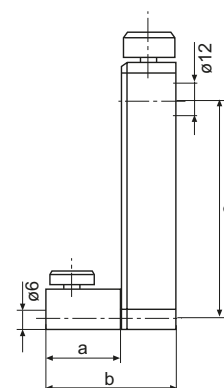

ACCESSORIES

Order no.	Product name	Product type
4301865	Mounting shaft \varnothing 6 mm for touch probes	800 a6
4429158	Spherical probe, \varnothing 5.0 mm	K 5/51
4429226	Disc probe \varnothing 15 mm	S 15/31.2
4429227	Cylindrical probe \varnothing 10 mm	Z10/31.2
4429228	Taper probe	MKe 30
4429254	Spherical probe for 817 CLM, \varnothing 6 mm	K 6/51
4429256	Probe including styli 800 ts \varnothing 2.0 mm	KM 2

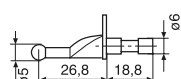

K 5/51

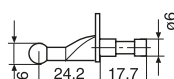

K 6/51

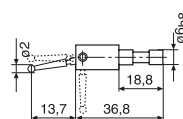

KM 2

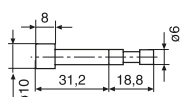

Z 10/31.2

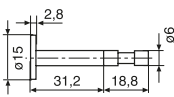

S 15/31.2

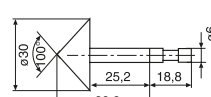

MKe 30

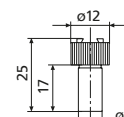

800 a6

Digimar 817 h4

Probe carriers 817 CLM

FEATURES

- Carrier for measuring anvils with 8 mm holding shaft and weighing 102 g
- Suitable for the CXt2 universal measuring probe set
- Compatible with Digimar CX1 and CX2 probes weighing 102 g



TECHNICAL DATA

Order no.	Product type	Mounting hole
4429220	817 h4	8 mm

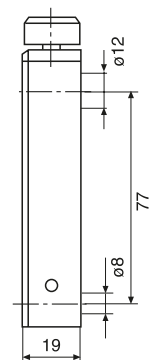

ACCESSORIES

Order no.	Product name	Product type
3015888	Extension M3 - M2.5, d = 4 mm, l = 20 mm	V/M 2.5
3015917	Probe carrier	GK/8
3015918	Measuring crook, d = 0.5 mm, l = 78 mm	TS 0.5/78
3015919	Probe pin/tip, d = 1.2 mm, l = 75 mm, ls = 15.5 mm	T 1.2/75
3015920	Taper probe	MKe 8
3015921	Extension M3 - M3, d = 4 mm, l = 20 mm	V/M 3
3022000	Spherical probe, d _k = 3.0 mm, l = 24 mm	K 3/24
3022001	Spherical probe, d _k = 2.0 mm, l = 24 mm	K 2/24
3022002	Spherical probe, d _k = 1.0 mm, l = 24 mm	K 1/24
7023615	Probes with mount, ø 10.0 mm	K 10/100
7023810	Probes with mount, ø 10.0 mm	K 10/60
7023813	Probe with mount, ø 4.0 mm	K 4/30
7023816	Probes with mount, ø 6 mm	K 6/40

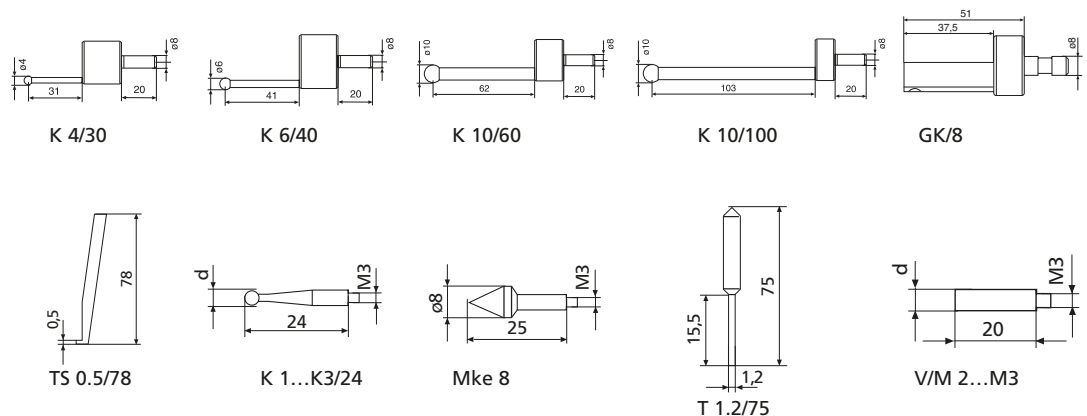

Digimar TMT 120 / TMT 120 S

Depth probe including holder

FEATURES

- Depth probe and carrier for measurements in vertical bores and recesses
- Interchangeable depth probe
- M2 and M2.5 connecting threads for measuring anvils
- M2.5 spherical contact point
- 901 H
- pivoting (TMT 120 S only)
- Second depth probe with probe shoe for groove measurement (TMT 120 S only)
- M2 stylus 800 ts with 2 mm ball (TMT 120 S only)

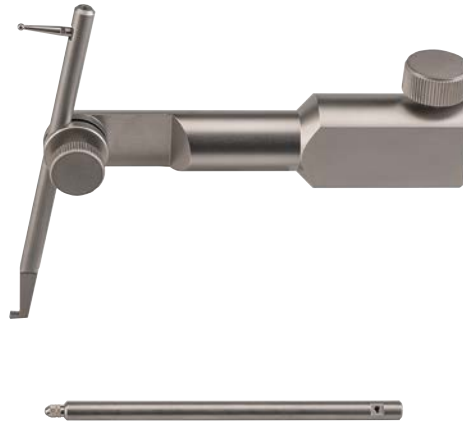

TECHNICAL DATA

Order no.	Product type
4429221	TMT 120
4429421	TMT 120 S

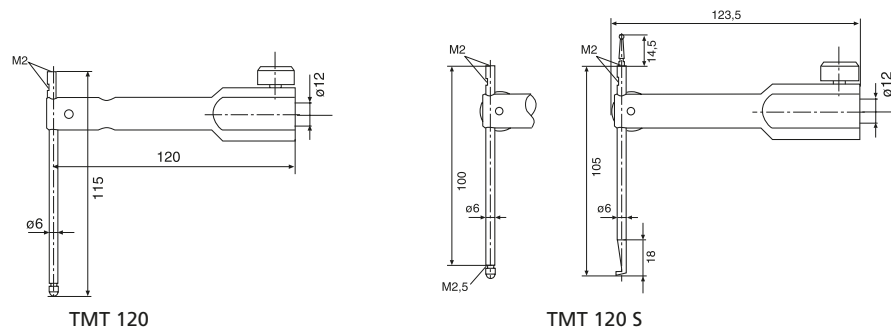

ACCESSORIES

Order no.	Product name	Product type
4305870	Stylus \varnothing 1.0 mm, carbide, $l = 14.5$ mm	800 ts
4305850	Stylus \varnothing 2.0 mm, carbide, $l = 14.5$ mm	800 ts
4305871	Stylus \varnothing 3.0 mm, carbide, $l = 14.5$ mm	800 ts
4309051	Stylus \varnothing 2.0 mm, ruby, $l = 14.5$ mm	800 tsr
4360001	Standard contact point, steel, $r = 1.5$ mm	901
4360002	Standard contact point, carbide, $r = 1.5$ mm	901 H
4360003	Standard contact point, ruby, $r = 1.5$ mm	901 R
4360241	Pin contact point, carbide, $l = 11$ mm, measuring surface \varnothing 1.5 mm	911 H2

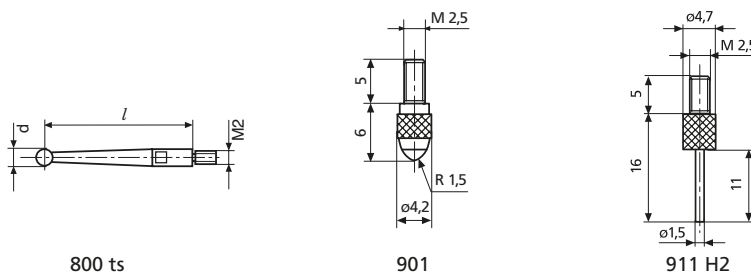

Digimar 817 h3

Carrier for checking perpendicularity

FEATURES

- Carrier for perpendicularity measurement
- Suitable for analog and digital dial indicators
- Ideal with P1514H measuring probe (817 CLM only)



TECHNICAL DATA

Order no.	Product type
4429206	817 h3

Order no.	Mounting hole
4429206	8 mm

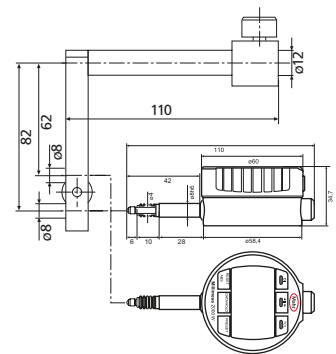

ACCESSORIES

Order no.	Product name	Product type
4429610	Data connection cable RS232C (2 m)	DK-M1
4346700	Digital indicator 0.0001mm/±1mm	2000 W
4346800	Digital indicator 0.0001mm/±1mm	2001 W



2001 W



2000 W



DK-M1

Millimess 2001 Wi: Everything under control! A digital dial comparator – highest level of precision thanks to inductive measuring system



Integrated Wireless

- Integrated wireless interface
- Sending and receiving measuring data and various parameters



Lock individual keys and functions

Remote-controlled settings can be configured easily using MarCom Professional software



Can be configured and controlled remotely using MarCom Professional software



First digital comparator indicator with touch operation



Unique touch operation – even works with gloves

Enormous advantages:

- Keys react even with the slightest touch
 - This prevents a measuring device from being adjusted or deformed
- **Maximum measuring certainty**

Hardened glass front

- Scratch and impact-resistant surface
- Excellent protection against scratches and penetrating liquids
- Wear-free keys react to the slightest touch



Protection rating IP 64

Excellent protection against dust and splash water from all directions ensures optimum workshop compatibility at all times



High-precision ball-bearing guide

Maximum sensitivity of the measuring system. long service life, and high loading capacity

Bi-directional data interface via USB

- Sending and receiving measuring data and various parameters
- Permanent power supply via data cable
- Possible to retrieve the device ID

#ID

Data interface via Digimatic

- To send measuring data



Convenient tolerance functions

- Clear tolerance symbols
- Colorful LED signals (red, green, yellow) to classify the measuring values
 - No go/Go/warning limit
 - No go/Go/rework

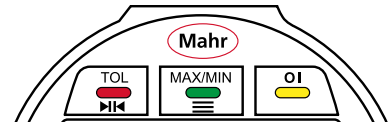

High precision inductive measuring system

Lowest measuring deviations thanks to linearization

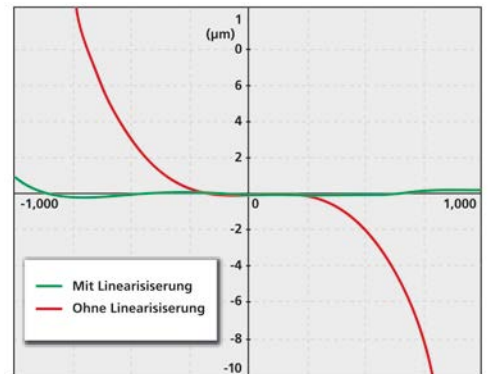

ABS system

Absolute measuring system

The reference to the electric zero point is not lost when the device is switched off

Millimess 2000 W / 2000 Wi

Inductive comparator



FUNCTIONS

- ON/OFF
- mm/inch
- RESET (set display to zero)
- PRESET (for entering a numerical value)
- ABS (reference to the electrical zero point)
- Selectable resolution
- TOL (Tolerance and Warning Limits Input)
- Factor (adjustable)
- Reversal of counting direction
- HOLD (storage of measured values)
- LOCK function (key lock)
- DATA (data transmission)
- Bi-directional data interface (external output and input option of characteristic values as well as setting of individual lock functions by software MarCom)

FEATURES

- **Tempered glass front with touch control panels with enormous advantages:**
 - scratch and impact resistant surface
 - excellent protection against dust, coolants and lubricants
 - wear-free touch operating keys
 - improved safety of measurement values in measuring stands, as only a light touch of the key – no keystroke is required, thus no adjustment or deformation of the measuring device
- High-contrast LCD display, thus very clear and safe to read
- Clear tolerance symbols and colored LED signals (red, green, yellow) for measured value classification
 - **with** warning limit input: No Go / Go / Warning Limit
 - **without** warning limit input: No Go / Go / Rework
- Operating and display unit (bezel) can be rotated through 280°
- Mounting shank and measuring spindle are both made of hardened stainless steel
- Measuring spindle is mounted in a high-precision ball guide for minimal hysteresis
- Linearized inductive absolute measuring system
- Measuring force spring is interchangeable
- Lower stop is adjustable
- Software: MarCom Professional free download: www.mahr.com/marcom (only for Mahr data cables and wireless systems with USB and RS-232 interface)

Application:

For static measuring tasks



TECHNICAL DATA

Order no.	4346700		4346701	
Type	2000 W		2000 Wi	
Measuring range	mm	± 1		
Resolution	mm	0.0001, 0.0002, 0.0005, 0.001, 0.002, 0.005, 0.01		
Resolution	inch	.000005", .00001", .00002", .00005", .0001", .0002", .0005"		
Error limit	µm	± (0.2 + 0.5 x L) L in mm		
Measuring value hysteresis f _u	µm	0.3		
Repeatability f _w	µm	0.1		
Standard	Factory standard			
Free stroke	mm	2.5		
Measuring force	N	0.9±0.1 (Reference to absolute zero point of inductive measuring system)		
IP protection category	IP 64			
Supply voltage	100– 240 V			

- Digit height: 11.5 mm
- Data interface: USB, Digimatic
- Energy supply: Integrated rechargeable accumulator (up to 4 weeks) or powered by USB Data Cable
- Battery type: Lithium polymer battery 3.7 V
- Package contains: instruction manual, USB data and charging cable type DK-U1, plug-in power supply (with 4 interchangeable adapters) for USB, rubber bellows, screwdriver for pre-stroke adjustment (hexagon socket 0.9 mm), case

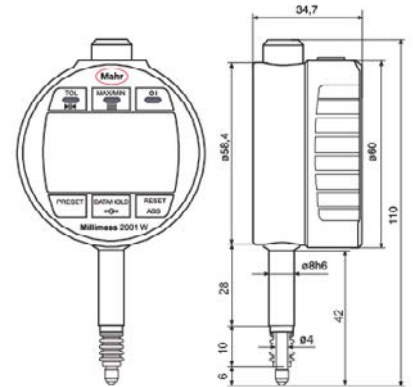

Millimess 2000 W / 2000 Wi

Inductive comparator

ACCESSORIES

Order no.	Description	Type
4102603	Data cable USB bi-directional (2 m)	DK-U1
4102606	Interface adapter with data cable Digimatic (2 m)	DK-D1
4310103	Adapter bushing (.375" / 8 mm)	940
4346010	Manual lifter with cable release	2000 h
4346011	Pneumatic lifter	2000 p
4346012	Measuring force adjuster	2000 m
4337421	Lug back	1086 b
4346050	Measuring force spring 0.25 N	
4346051	Measuring force spring 0.50 N	
4882284	Measuring force spring 0.75 N	
4346052	Measuring force spring 1.00 N	
4346053	Measuring force spring 1.50 N	
4346054	Measuring force spring 2.00 N	
4346055	Measuring force spring 2.50 N	
4337900	Display protection film, anti reflective frosted, made of extra hard hybrid glass, to protect against scratches and reflections	1086 sf
4346606	Shock protection ring made of hard rubber for Millimess 2000 W(i) / 2001 W(i)	1086 sr
4102220	Receiver for instruments with Integrated Wireless	i-Stick

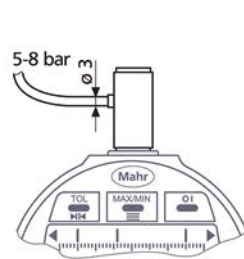

2000 p

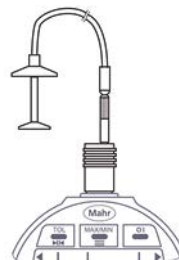

2000 h



2000 m



1086 sf



1086 sr



i-stick

ACCESSORIES

Order no.	Description	Type
4102603	Data cable USB bi-directional (2 m)	DK-U1
4102606	Interface adapter with data cable Digimatic (2 m)	DK-D1
4310103	Adapter bushing (.375" / 8 mm)	940
4346010	Manual lifter with cable release	2000 h
4346011	Pneumatic lifter	2000 p
4346012	Measuring force adjuster	2000 m
4337421	Lug back	1086 b
4346050	Measuring force spring 0.25 N	
4346051	Measuring force spring 0.50 N	
4882284	Measuring force spring 0.75 N	
4346052	Measuring force spring 1.00 N	
4346053	Measuring force spring 1.50 N	
4346054	Measuring force spring 2.00 N	
4346055	Measuring force spring 2.50 N	
4337900	Display protection film, anti reflective frosted, made of extra hard hybrid glass, to protect against scratches and reflections	1086 sf
4346606	Shock protection ring made of hard rubber for Millimess 2000 W(i) / 2001 W(i)	1086 sr
4102220	Receiver for instruments with Integrated Wireless	i-Stick

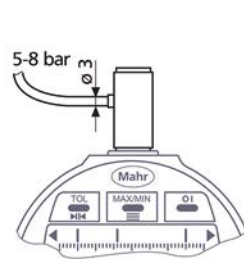

2000 p

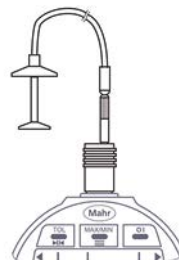

2000 h



2000 m



1086 sf



1086 sr



i-stick

Millimes 2001 Wi

Inductive comparator



FUNCTIONS

- ON/OFF
- RESET (set display to zero)
- PRESET (for entering a numerical value)
- ABS (reference to the electrical zero point)
- Selectable resolution
- TOL (Tolerance and Warning Limits Input)
- RANGE (switch the measuring range and resolution)
- MAX/MIN memory for searching the reversal point
- (MAX-MIN) for testing flatness and concentricity
- 0 (set the analog scale display to zero)
- Factor (adjustable)
- Reversal of counting direction
- HOLD (storage of measured values)
- LOCK function (key lock)
- DATA (data transmission)
- Bi-directional data interface (external output and input option of characteristic values as well as setting of individual lock functions by software MarCom)

FEATURES

- Unit of measurement METRIC only (no INCH)
- Tempered glass front with touch control panels with enormous advantages:
 - scratch and impact resistant surface
 - excellent protection against dust, coolants and lubricants
 - wear-free touch operating keys
 - improved safety of measurement values in measuring stands, as only a light touch of the key
 - no keystroke - is required, thus no adjustment or deformation of the measuring device
- Clear tolerance limits in the scale display and colored LED signals (red, green, yellow) for measured value classification
 - with warning limit input: No Go / Go / Warning Limit
 - without warning limit input: No Go / Go / Rework
- LED signals (red, green, yellow) in mode:
 - powered by Accumulator: flashing signal (1 sec.)
 - powered by data cable DK-U1: permanent
- High contrast LCD display, thus very clear and safe to read
- Analog scale display for visual recognition of the measuring movement during dynamic measurement tasks such as checking of concentricity or flatness as



Application:

For static and dynamic measuring tasks

Version: Unit of measurement only METRIC (without INCH)

TECHNICAL DATA

Order no.		4346811
Product type		2001 Wi
Measuring range μm	mm	± 1
Resolution	mm	0.0001, 0.0002, 0.0005, 0.001, 0.002, 0.005, 0.01
Error limit	μm	$\pm (0.2 + 0.5 \times L)$ L in mm
Measuring value hysteresis f_u	μm	0.3
Repeatability f_w	μm	0.1
Norm		Factory standard
Free stroke	mm	2.5
Measuring force	N	0.9 ± 0.1 (Reference to absolute zero point of inductive measuring system)
Range of analog display	mm	$\pm 0.002, \pm 0.004, \pm 0.01, \pm 0.02, \pm 0.04, \pm 0.1, \pm 0.2$
IP protection category		IP 64
Supply voltage		100– 240 V

- well as for reversal point search during bore measurements
- Operating and display unit (bezel) can be rotated through 280°
- Mounting shank and measuring spindle are both made of hardened stainless steel
- Measuring spindle is mounted in a high precision ball guide for minimal hysteresis
- Linearized inductive absolute measuring system
- Measuring force spring is interchangeable
- Lower stop is adjustable
- Software: MarCom Professional free download: www.mahr.com/marcom (only for Mahr data

- cables and wireless systems with USB and RS- 232 interface)
- Digit height: 9 mm
- Data interface: Integrated wireless, USB, Digimatic
- Energy supply: Integrated rechargeable accumulator (up to 4 weeks) or powered by USB Data Cable
- Battery type: Lithium polymer battery 3.7 V
- Package contains: instruction manual, USB data and charging cable type DK-U1, Plug-in power supply (with 4 interchangeable adapters) for USB, rubber bellows, Screwdriver for pre-stroke adjustment (hexagon socket 0.9 mm), case

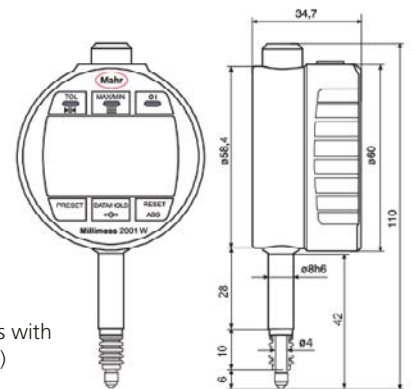

ACCESSORIES

Order no.	Description	Type
4102603	Data cable USB bi-directional (2 m)	DK-U1
4102606	Interface adapter with data cable Digimatic (2 m)	DK-D1
4310103	Adapter bushing (.375" / 8 mm)	940
4346010	Manual lifter with cable release	2000 h
4346011	Pneumatic lifter	2000 p
4346012	Measuring force adjuster	2000 m
4337421	Lug back	1086 b
4346050	Measuring force spring 0.25 N	
4346051	Measuring force spring 0.50 N	
4882284	Measuring force spring 0.75 N	
4346052	Measuring force spring 1.00 N	
4346053	Measuring force spring 1.50 N	
4346054	Measuring force spring 2.00 N	
4346055	Measuring force spring 2.50 N	
4337900	Display protection film, anti reflective frosted, made of extra hard hybrid glass, to protect against scratches and reflections	1086 sf
4346606	Shock protection ring made of hard rubber for Millimess 2000 W(i) / 2001 W(i)	1086 sr
4102220	Receiver for instruments with Integrated Wireless	i-Stick

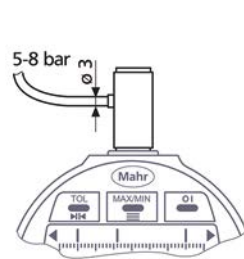

2000 p

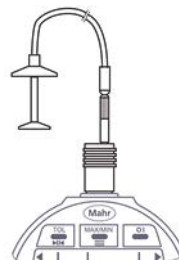

2000 h



2000 m



1086 sf



1086 sr



i-stick

Mar4D PLQ 4200: Fast and precise measurement during production

The cylinder coordinate measuring machines from the Mar4D PLQ 4200 product line measure rotationally symmetrical workpieces with more flexibility and more conveniently than ever before. They operate at the highest speed and level of precision providing fast and reliable measuring results.

With the Mar4D PLQ 4200, Mahr provides its customers with a high-performance measurement solution for complex rotationally symmetrical workpieces. The multisensor system covers a particularly broad range of dimensional measuring tasks. The new machine also has a particularly sturdy design enabling 3D measurements to be completed directly during production, as well as offering shorter processing times and thus increased throughput and excellent productivity rates.



+ Advantages

- Future-proof thanks to combined measuring technology: optical and tactile solution in one machine
- Versatile: Check several features such as the length, diameter, form, position, contour, roundness, roughness, or 3D geometries, such as the symmetry, during a single measuring run
- Fast and precise: Unique speed and optimum axis accuracy even as the tolerances become smaller achieved thanks to specially developed control architecture
- Flexible for workpieces with a diameter up to 200 mm, a length of up to 1000 mm. and a weight of up to 50 kg
- Ergonomic operation and unique safety concept

Fast alignment

The motorized tailstock with clamping force monitor secures the workpieces perfectly without operator intervention.

Process reliability when measuring

Monitoring systems in the machine record and compensate for external influences, such as temperature, vibrations and position in real-time.

Ergonomic design

The sophisticated design of the machine guarantees easy and safe operation.

Reliable software

Thanks to its clearly structured user interface, the MarWin platform software is very user friendly: learn once, apply again and again.

Universally applicable

The multisensor technology of the Mar4D PLQ 4200 enables measurement of various rotationally symmetrical workpieces directly in production.



Detailed information can be found on our website.
<https://metrology.mahr.com/en/mar4d-plq>

Mar4D PLQ 4200

Cylinder coordinate measuring machine

FEATURES

Fast and precise measurement in production

- Easy to operate
- Process reliability when measuring
- Ergonomic design
- Reliable software
- Universally applicable
- Telecentric precision lens



TECHNICAL DATA

Order no.		5554200	5554201	5554202
Type		PLQ 4200-T2 Z=450	PLQ 4200-T2 Z=730	PLQ 4200-T2 Z=1000
Dimensions W/H/D	mm	800 / 2200 / 1800	800 / 2500 / 1800	800 / 2200 / 1800
Workpiece weight	kg		max. 20 (optional 50)	
Workpiece dimensions	mm	450	730	1000
Max. diameter	mm	200		
Measurement resolution		Adjustable		
Lengths/diameters	mm	0.01...0.0001		
Lengths/diameters	inch	0.001...0.0001		
Angle		0.01...0.0001 degrees (decimal) or degrees, minutes, seconds		
Error limit only diameter, $E_{BxZ, MPE}^*$	μm	$\leq (1 + L/150)$ L in mm		
Error limit only parallel length Z, $E_{BxZ, MPE}^*$	μm	$\leq (2 + L/200)$ L in mm		
Travel speed Z		max. 200 mm/s		
Travel speed X1		max. 200 mm/s		
Travel speed X2		max. 50 mm/s		
Travel speed C		max. 2.0 1/s		
Travel speed Y		max. 50 mm/s		

* Tempered workpiece at $t=20 \pm 2^\circ\text{C}$, on smooth surfaces ($R_z < 1 \mu\text{m}$) DIN EN ISO 10360-7

Subject to change without notice.



Tactile measurements with SP25



Tactile measurements with T7W



Optical measurements



Control panel

Mar4D PLQ 4200

Cylinder coordinate measuring machine

ACCESSORIES

Order no.	Description	Type
5361112	Centering tip 60°, Ø 2–15 mm, height 35 mm	
5361223	Centering tip 60°, Ø 2–44 mm, height 46 mm	
5361105	Centering tip 60°, Ø 3–15 mm, height 25 mm	
5361106	Centering tip 60°, Ø 2–19 mm, height 44 mm	
9056631	Centering tip 60°, Ø 2–35 mm, height 46 mm	
5361104	Hollow tip 90°, Ø 6–20 mm, height 56 mm	
3026166	USB keyboard - German	
3026167	USB keyboard - English	
5550400	Motorized tactile probe	T7W
5400211	Probe set	T7W
5550250	Renishaw tactile probe	SP25M
5550251	Probe set 1 for SP25	
5550252	Probe set 2 for SP25	
5550083	MarControl manual control panel	
5550085	Second monitor plus holder	
5550080	Housing plus package	
5550084	Industrial PC	
5550086	Panel PC included in measuring station scope	
5550091	Passive, controlled vibration isolation system	
5550100	MarWin complete package	Mar4D
5550460	OPTIONAL roughness measurement T7W for PLQ 4200	
5480638	Optional roughness software for AdvancedForm	
5360581	3D contour standard (without calibration certificate)	
9964316	Mahr calibration certificate for contour standard	
6980110	DAkkS / DKD calibration for contour standard	



Centering tip 60°
Ø 2 – 15 mm



Centering tip 60°
Ø 2 – 44 mm



Centering tip 60°
Ø 3 – 15 mm



Centering tip 60°
Ø 2 – 19 mm



Centering tip 60°
Ø 2 – 35 mm

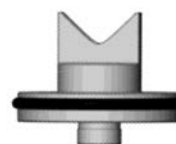

Hollow tip 90°
Ø 6 – 20 mm

MarSurf CD 140 AG 11: All-rounder with intelligent probe system

Mahr has launched a new contour measuring machine on the market – the MarSurf CD 140 AG 11. Its probe system has a measuring range of up to 70 mm and the stylus tips can be replaced quickly and without any tools – without having to recalibrate the system

The new contour measuring machine MarSurf CD 140 AG 11 enables the user to complete fast and precise measurements. Its flexible workpiece holder makes it particularly easy to handle, while users are also convinced by its extreme versatility – it can also be used to measure roughness. The intelligent probe system and magnetic stylus tip holder ensure the process to replace stylus tips without any tools is the most straightforward process to date. Operators can also choose from a comprehensive range of clamps and workpiece holders. The new MarSurf CD 140 AG 11 can be used in a static position or directly at the location of the workpiece.

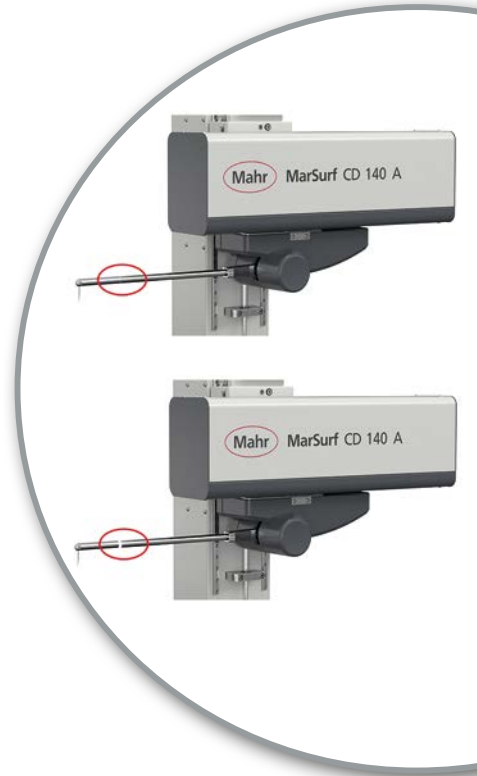

+ Advantages

- Comprehensive contour measurement functions – fast and simple
- Quick adjustment of the Z-axis with handles that are simple to operate
- Replacement of the stylus tip without any tools
- Travel speed in the X-axis of up to 200 mm/s
- Simple program creation or single measurement using MarWin
- Automatic evaluation, best adjustment of contours, CAD contour comparison, and a lot more
- Flexible support plate with 50 mm bore grid for KMG workpiece holder, amongst other
- Optionally expandable with option of roughness measurements ($R_z > 2 \mu\text{m}$)
- Measurement with double stylus



Plug-in guide stops and a wide range of standardized clamping devices as well as workpiece holders enable flexible positioning of your testpiece.

Manual quick adjustment

The fine adjustment is located in the Z-axis and moves the X-axis up and down.

Unique probe system

The probe system with a probe arm length of 350 mm enables a quick change of stylus tips without any tools and without having to recalibrate. The automatic tracing force selection guarantees the correct tracing force is selected when replacing several stylus tips.

X-axis with maximum measuring range

The high-speed X-axis is designed for a large measuring range of 140 mm.

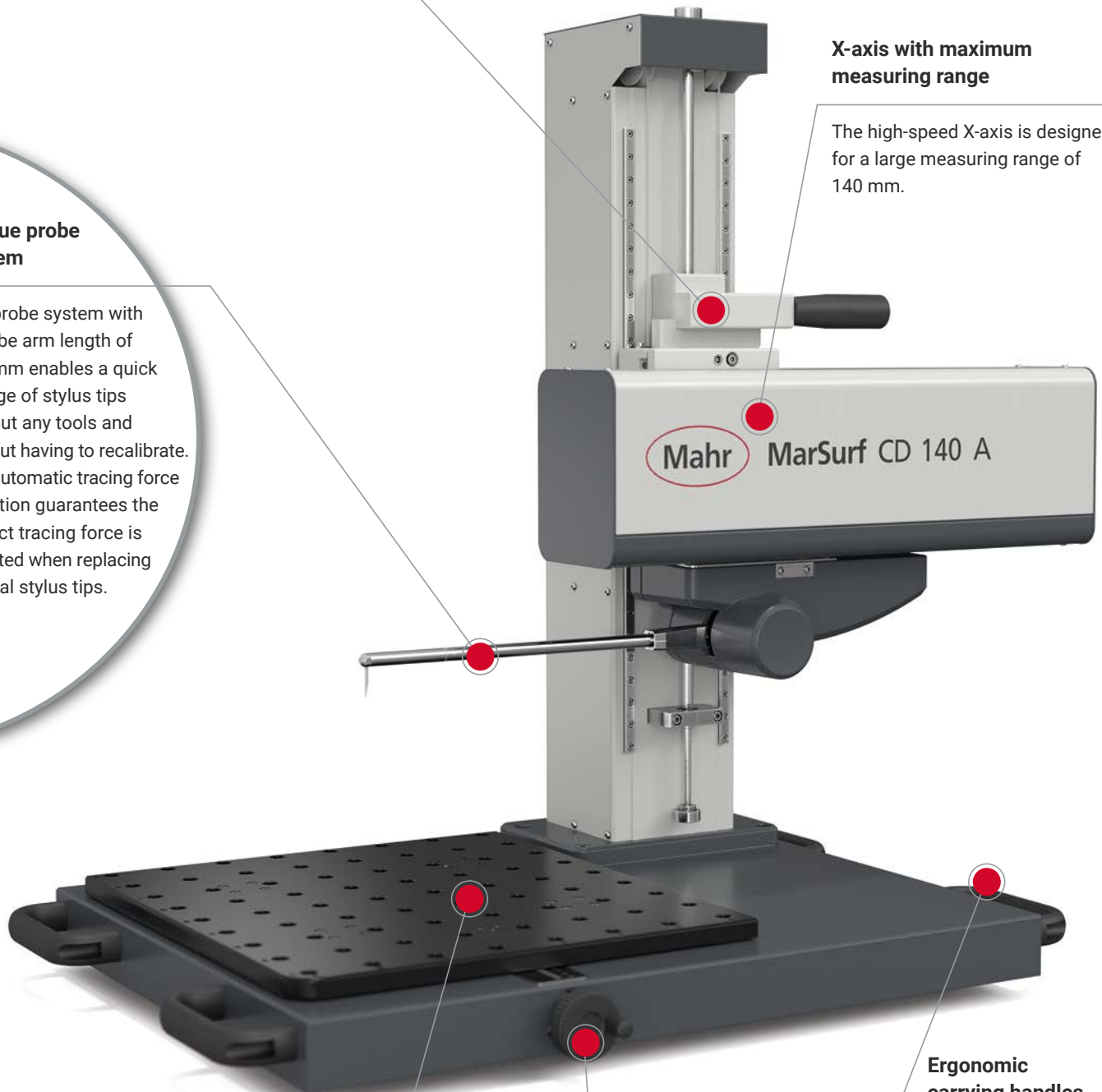

Support plate also for large components

The 390 mm x 450 mm large plate with 50 mm matrix of holes is also suitable for large-volume workpieces. This provides a variety of flexible clamping options.

Generous traverse path

The Y-axis can be adjusted manually with a traverse path of 60 mm.

Ergonomic carrying handles

The handles on the side make it easy to transport the device.

MarSurf CD 140 AG 11

Contour measuring station

FEATURES

- Fast and precise measurements
- Easy to operate
- Use in a static position or directly at the location of the workpiece
- Manual fine adjustment of the drive unit in the Z-axis
- Stylus tip holder can be used without any tools
- A 390 mm x 450 mm support plate with 50 mm matrix of holes
- High-speed measuring X-axis (140 mm)
- Carrying handles for simple transport
- Quick adjustment of the Z-axis
- Unique adjustment lock secures the adjusted measuring setup
- 350 mm traverse path
- Fast change of stylus tips without tools and without having to recalibrate

Probe system

- Automatic measuring force selection of the correct tracing force when switching between several stylus tips
- Large measuring range – 70 mm
- Probe arm length – 350 mm
- Automated calibration routine for probe arms
- Simple calibration of standard and double probe arms possible
- Simple and repeatable calibration pattern positioning using 50 mm grid
- Magnetic probe arm holder enables probe arm change without tools
- Defined start position
- Aligned axis saving time during preparations

Software

- Simple and intuitive contour measurement and evaluation.
- The measuring assistant will guide you specifically to your measuring data.
- Many measuring tasks – for example for calculating radii, arc lengths, distances, angles etc. – are already pre-programmed for you.
- One particular highlight is the patented “tangential elements” function. This helps evaluate the tangential transitions between radii and straight lines easily and independently of the user.



TECHNICAL DATA

Order no.	6269033
Product type	CD 140 AG 11
Positioning speed	0.1 - 200 mm/s (in X)
Tracing distance (in X) end	140 mm
Measuring speed	0.1 - 10 mm/s
Guide deviation	1 µm / 140 mm
Probe arm length	350 mm
Resolution	19 nm
Measuring range in Z	70 mm
Measuring force (N)	4 mN to 30 mN, in Z+ and Z-, adjustable via software
Dimensions (T x B x H)	572 x 905 x 822 mm

APPLICATIONS

Mechanical engineering

- Bearings, threads, threaded rods, ball spindles, shafts, racks

Measurements close to production

- Semi-automatic contour measurement

Automotive Industry

- Steering, brake system, transmission, crankshaft, camshaft, cylinder head

Medical technology

- Contour of the hip and knee endoprostheses, contour on medical screws, contour on dental implan



For more information, please visit our website: www.mahr.com

ACCESSORIES

Order no.	Description	Type
6820020	DK accessory box including clamping elements	
6820022	Quick clamp swivel unit +90° / -55°	
6820023	Precision three-jaw chuck 50 mm	
6820001	Vee-block set AF 25	
6820002	Delta block set AF 25	
6820004	Screw jack set	
9059081	Precision clamp UZS 15	
6820000	Contour standard – contour B for support plate with 50 mm bore dimension	
6820010	Universal standard holder	
6820125	Contour standard KN 100	
6980110	DAkS/DKD calibration including calibration certificate	
9964316	Mahr calibration including calibration certificate	
6820003	Retainer set AF 25	
6820005	Manual chuck set, Alufix	
6820021	Base plate for DK systems	
6820024	Precision vise 25 mm	
6820025	Vee-block 90°	
6820026	Spring compressor with attachment	
6820027	Quick clamp with 45° angle element	
6820011	Adapter plate for 50 mm	
9000250	Centric clamp with spread up to 45 mm	
9000249	Universal coupling including adapter plate	
9000248	Parallel vise with spread up to 40 mm	
9026049	Table plate 740 x 430 set	



Vee-block set AF 25



Delta block set AF 25



Screw jack set



Precision clamp UZS 15



Contour standard KN 100



2-sphere calibration standard



For more information, please visit our website: www.mahr.com

Measuring system MFU 200: one machine – **two ultra precise versions**

The proven Mahr MFU measuring system is available in two versions for different applications: MFU 200 for testing form and position of rotationally symmetrical workpieces and MFU 200-3D for measuring components in the optical industry.

MFU has stood for accuracy and stability for many years. Thanks to its universality and ultraprecision it has qualified as a highly precise reference measuring system. The highest measuring certainty increases the tolerance margin for production, optimizes processes, and ultimately reduces production costs.



Advantages of the MFU 200

- High precision thanks to nanometer machine accuracy for workpiece tolerances of 0.5 µm
- Simple to operate providing fast and simple access to the measuring result in just a few seconds – even for a new workpiece
- User-friendly software platform MarWin for form, gear, contour, shaft, roughness – learn once, apply again and again.
- Future-proof thanks to software upgrade options: lead, roughness, contour, chatter marks, Capto, commutators



Additional advantages of the MFU 200-3D

- Equipped with optical IPS sensor and MarOpto clamp set for the qualification of spheres, aspheres, and freeforms in the optical industry
- Clear and user-friendly software platform AsphericLib for measuring and evaluating spheres and aspheres
- Measure freeforms flexibly with the clearly laid-out Aspheric Lib software platform and evaluate them using the Anyshape software
- Optimum performance: Form deviations <100 nm (PV) in 2D and 3D

Maximum precision

The MFU 200 concept ensures accuracy in the nanometer range.

Most reliable repeatability

With an absolute positioning accuracy of 0.001 mm within the space, this provides the best possible reproducibility and process capability.

Measurements without user intervention

The fully automated measuring process with motorized centering and tilting means that user intervention is no longer required thus ensuring process stability.



Shorter measuring times

The high-speed C-axis accelerates the measurements considerably thus increasing productivity.

High-performance checks

The motorized T7W measuring probe and the probe arms arranged in the shape of a star combined tacitly and optically with the IPS sensor allows for flexible scanning and user-friendly operation.

MFU 200

Reference form measuring station

DESCRIPTION

- Reference form measuring station in a new dimension
- The journey from high precision measuring axes to competent measurements is often a long one that the **MFU 200** has mastered completely. Only the **MFU 200** has integrated reference elements for the real-time spatial compensation of geometric deviations, recording all profiles as high precision 3D coordinates.
- For decades, **MarForm** measuring machines have been recognized for their accuracy and stability. The new **MFU 200** was developed with the claims of testing the shape and position features of product parts in a one liter measuring volume close to the production area and at a reasonable cost. In doing so, it has taken our long experience into a new dimension.
- **MFU 200** is a precision reference form measuring center. Its exceptionally low measurement uncertainty increases the tolerance margin for your production processes, thereby lowering production costs.

The form measuring center consists of the following components:

- Circular roundness measuring axis (C)
- Motorized centering and tilting table (X, Y, A, B)
- Roundness measuring axis circular (C- high-speed, up to 200 U/min)
- Vertical straightness measuring axis (Z)
- Horizontal straightness measuring axis (X)
- Tangential multifunction axis (Y)
- Motorized length measuring probe T7W
- MarWin Evaluation Software for form and position features
- The consistent separation of control and evaluation makes **MFU 200** future-proof and expandable. New language versions can be implemented just as effectively as special evaluations and new standards. The **MFU 200** is also already prepared for the use of optical sensor technology, the MarForm IPS, and can thus also measure micro surface structures with high precision.
- In short: **MFU 200** brings form measuring machines for inspection rooms and production areas into a new dimension.



TECHNICAL DATA

Order no.	5440580
Type	MFU 200
Monitor	19" TFT monitor (touchscreen monitor)
Control panel	MCP 12
Motorized measuring probe	T7W
Probe arm	60 mm ø 1.0, ruby, M2, 60 degrees, prepared for the connection of the optical sensor IPS15
Pitch error	Pitch error of the C-/Z-/X-axis is calibrated

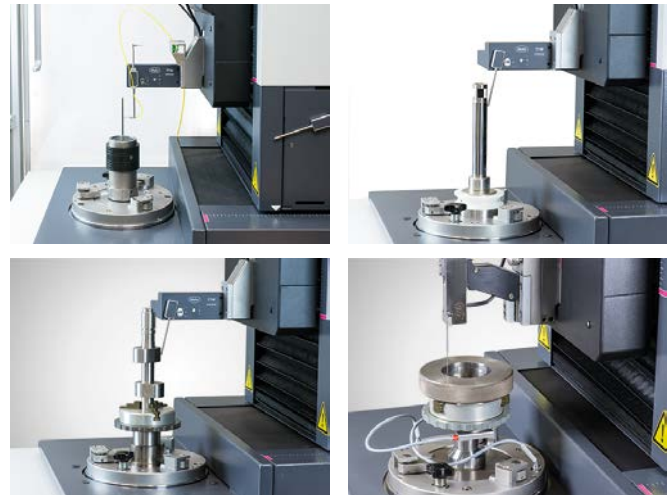

APPLICATIONS

- Checking product parts for form and position features
- Roundness, concentricity / coaxiality, cylindricity, concentricity, axial runout, axial runout, total runout, straightness, parallelism, squareness, inclination, flatness, conicity, diameter, taper, Fourier analysis (waviness analysis), line profile, area profile, cam shape
- Recording of all profiles as high-precision 3D coordinates with real-time
- Spatial compensation of geometric deviations
- Scanning of surfaces, roughness evaluation
- Scanning and evaluation of contours and shapes

ACCESSORIES

Order no.	Description
	Hardware (mandatory position)::
9028023	Calibration sphere Ø 15 mm with Mahr calibration certificate
9064901	with MarWin PC with WINDOWS 10, multi-lingual
3026857	Wireless keyboard K400 plus Logitec, German
3026858	Wireless keyboard K400 plus Logitec, English
6710620	Three-jaw chuck with flange, Ø 100 mm (NEW VERSION!). not to be used with basic holder
3017216	Basic holder for quick clamp/retriever interface
9004831	Rim chuck with three jaws, Ø 50 with column and flange for MFU quick clamp
	Software (optional/mandatory position):
5480312	ProfessionalForm software
5480311	AdvancedForm software
	Optical sensor for MFU 200 plus:
5400275	Interferometric controller with IPS15, including rack to hold the IPS box



Three-jaw chuck with column



Calibration sphere



Rim chuck



Rim chuck with collet chucks



For more information, please visit our website: www.mahr.com

MFU 200-3D

High-precision 3D measuring station for spheres, aspheres and freeforms

DESCRIPTION

- The MFU 200-3D is a universal, highly accurate measuring machine for the automatic measurement of spheres, aspheres, freeforms, and special lenses and was developed by Mahr to enable optical components to be tested quickly in 2D and 3D close to the production area.

Accuracy

- With a measurement uncertainty of less than 100 nm PV, the measuring instrument is perfectly designed to meet your process optimization requirements.

Flexibility

- The MFU 200-3D can perform optical and tactile measurements of surfaces. An interferometric point sensor is used for the optical measurement. There is a wide range of probe arms for tactile measurements. Rotationally symmetrical objects with a kurtosis of up to 45°, off-axis and freeforms up to 28° can be measured.



TECHNICAL DATA

Order no.	5440581
Type	MFU 200-3D
Monitor	19" TFT monitor (touchscreen monitor)
Control panel	MCP 12
Motorized measuring probe	T7W
Optical measuring probe	IPS
Probe arm	90° angled, ruby ball ø 3mm, incl. connection for optical sensor
Pitch error	Pitch error of the C-/Z-/X-axis is calibrated
Calibration set and Basic clamp set	included
MFU 200-3D Aspheric software package	included
MFU 200-3D Anyshape software option	optional

ACCESSORIES

Order no.	Description
5440468	Hydraulic expansion chuck ø 25 mm for quick clamp system
5440471	Three-jaw chuck for quick clamp system
5440472	Vise for quick clamp system
5440473	Index plate for quick clamp system
5440474	Mounting plate
3028108	Adapter for hydraulic expansion chuck 25 mm – 12 mm
9058047	Clamps for 200 mm lenses

Clamp set

Universal design for every purpose – the design ensures you are well equipped even if you have a broad range of components.

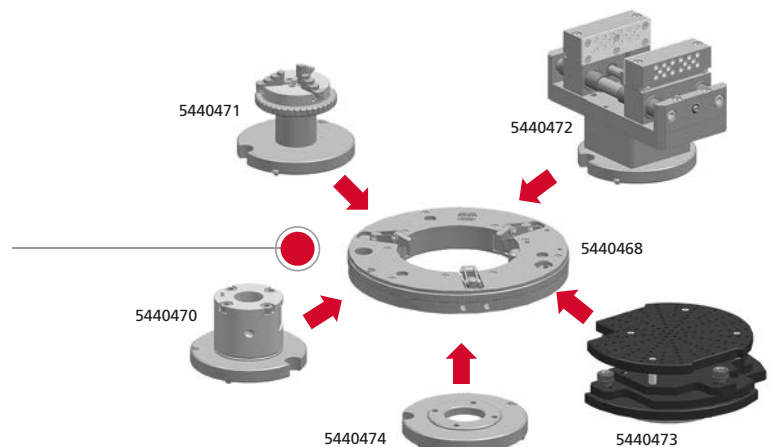

MFU 200-3D

High-precision 3D measuring station for spheres, aspheres and freeforms

Advantages:

- Automatic tilting and centering – user-independent positioning, centering, and alignment of measuring objects
- Active tracking – automatic measurement of unknown geometries; the sensor (optical and tactile) automatically follows the surface via the machine controller
- Probe combination – combination of optical sensors and tactile probes can be combined in one probe system; can be moved in space (360°)
- Closed loop integration in the production process (grinding/polishing) perfect for transmissive optics (tilt/centering error designation)



MEASURING TASKS & SOFTWARE

Flexible measuring tasks in one machine

- Form
- Contour
- Roughness
- Axis offset of lenses
- Radial runout error
- Tilt and centering error of the optics

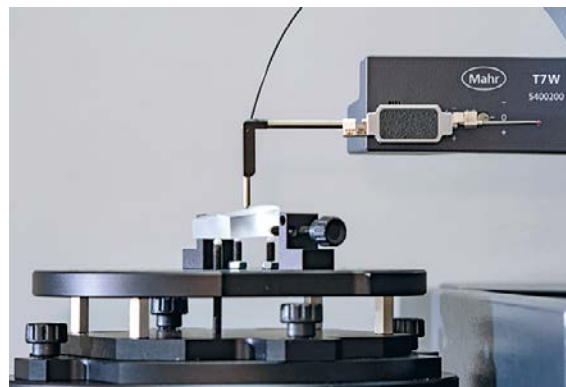

SOFTWARE

Special software package for your requirements

- AsphericLib software for measuring and evaluating spheres and aspheres
- SW analysis of the tool for the future – freeform measurement and evaluation

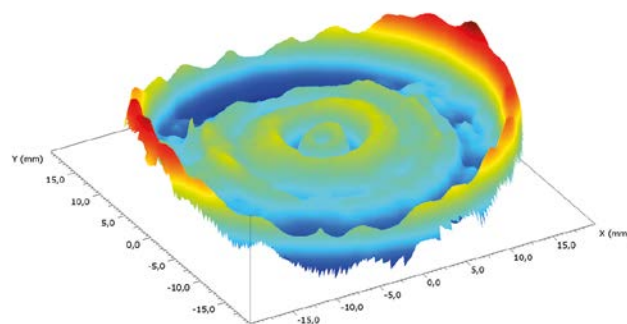

For more information, please visit our website: www.mahr.com



Mahr GmbH
Carl-Mahr-Straße 1
37073 Göttingen
Germany

Reutlinger Straße 48
73728 Esslingen
Germany

Tel.: +49 551 7073 800
info@mahr.com
www.mahr.com

© Mahr GmbH

We reserve the right to make changes to our products,
especially due to technical improvements and further developments.
All illustrations and technical data are therefore subject to change.

3765844 | 04.2022