

_OFFER VALID FROM 15.09 - 18.11.2023

TIGER·TEC® GOLD TURNING GRADES

WPP10G, WPP20G, WPP30G

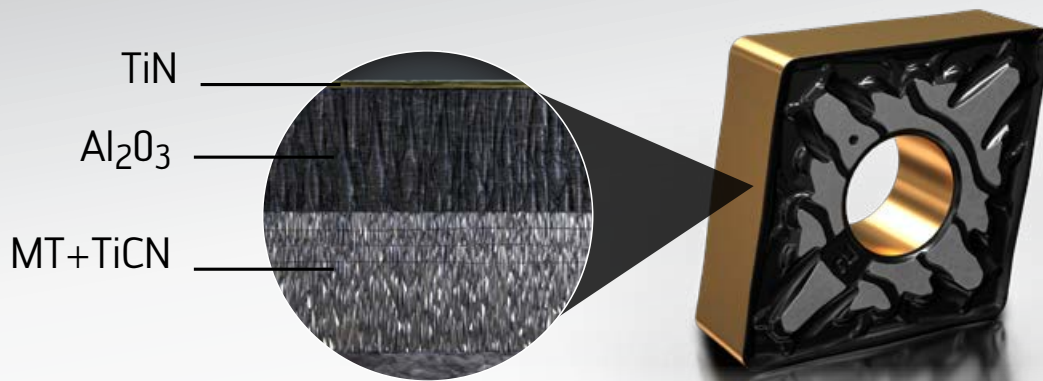

YOUR
ADVANTAGE

60%



TIGER·TEC® GOLD – STRONG IN STEEL AND AGAINST WEAR.

- Maximum process reliability
- High flexibility due to benchmark geometries
- + 50 % proven performance increase



Strong in steel and against wear.

THE GEOMETRY

- Negative geometry: FP5, MP3, MP5, MU5, RP5, RP7
- Positive geometry: FP4, MP4, RP4

THE GRADE

- New Tiger-tec® Gold coating: highly textured MT-TiCN - resistant to free-surface wear
- Multi-layer MT-TiCN structure improves the elastic property of the crystals
- Highly textured Al_2O_3 - for higher resistance to scour wear
- Multi-stage post-treatment for smooth rake face, reduced friction and improved toughness

THE APPLICATION

WPP10G

- Wear resistant with continuous cutting up to slight cutting interruptions
- Main application: Steel ISO P10;
Secondary application: cast iron ISO K20

WPP20G

- Universal grade with long service life and process reliability for approx. 50 % of all applications
- Main application: Steel ISO P20;
Secondary application: cast iron ISO K30

WPP30G

- Tough variety for cutting interruptions, unstable or unfavorable conditions
- Main application: steel ISO P30;
Secondary application: cast iron ISO K40 and stainless steel ISO M20.

Fine columnar, highly textured MT-TiCN – maximum resistance to free-surface wear



Highly textured Al_2O_3 – higher resistance to scour wear



Unique, multilayer MT-TiCN – higher toughness

Multi-stage post-treatment – smooth rake face, reduced friction and improved toughness.

Tiger-tec®Gold

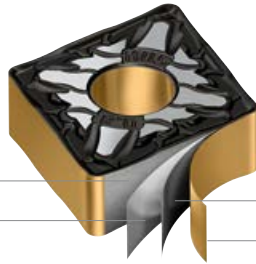

Carbide
 MT-TiCN – highly textured
 Al₂O₃ – highly textured
 Gold top layer

Fig.: Layer structure TTG

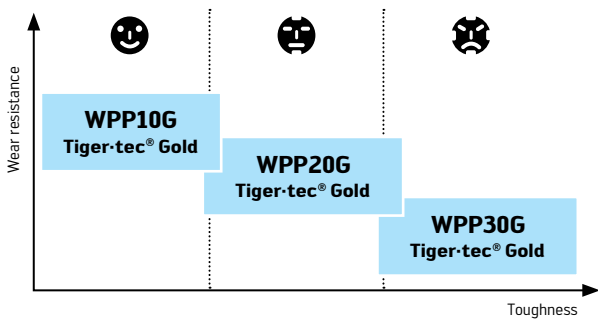

APPLICATION EXAMPLE

Transmission shaft –
 Internal machining, dia. 29 mm

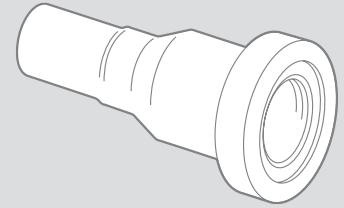

Material: 18MnCrS5/DIN 1.8720
 Tensile strength: 580 N/mm²
 Tool: E20S-SDUCR11-R
 Indexable insert: DCMT11T304-FP4 WPP20G

Cutting data

	Competitor ISO P20	Walter WPP20G Tiger-tec® Gold
v _c (m/min)	320	320
f (mm)	0.13	0.13
a _p (mm)	0.4	0.4
Cooling	Emulsion 15 bar	Emulsion 15 bar
Tool life (parts)	170	250

Comparison: Tool life quantity

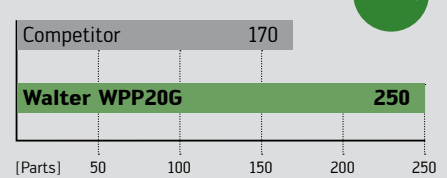

Conventional TiCN



Tiger-tec® Gold
 MT-TiCN –
 highly textured



High wear resistance and
 service life increase

Tiger-tec® Gold

Al₂O₃ –
 highly textured

MT-TiCN –
 highly textured

Carbide

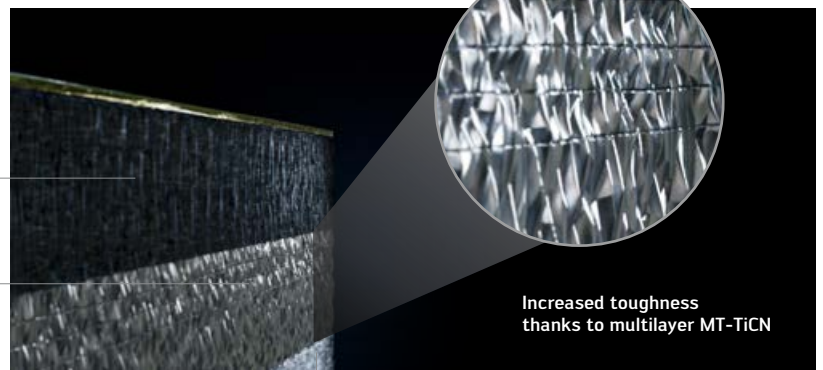

Increased toughness
 thanks to multilayer MT-TiCN

YOUR ADVANTAGES

- High productivity and process reliability thanks to multi-stage post-treatment and unique multilayer MT-TiCN structure
- Grades and benchmark geometries for short chips with flexible applicability
- High cost-effectiveness thanks to highly textured Tiger-tec® Gold coating – an average service life increase of around 50%

Order now and take advantage of the promotional discount!



	P	M	K	N	S	H	O
WPP10G	●●	●	●	●	●	●	●
WPP20G	●●	●	●	●	●	●	●
WPP30G	●●	●	●	●	●	●	●

Indexable insert

FP5 - Finishing



Product description	r [mm]	f [mm]	a _p [mm]	SAP No.	Quantity
CNMG120404-FP5PDW WPP10G	0,4	0.04 - 0.20	0.1 - 1.5	8387369	
CNMG120404-FP5PDW WPP20G	0,4	0.04 - 0.20	0.1 - 1.5	8388370	
CNMG120408-FP5PDW WPP10G	0,8	0.08 - 0.25	0.2 - 2.0	8388371	
CNMG120408-FP5PDW WPP20G	0,8	0.08 - 0.25	0.2 - 2.0	8388372	
DNMG110404-FP5PDW WPP10G	0,4	0.04 - 0.20	0.1 - 1.5	8388373	
DNMG110404-FP5PDW WPP20G	0,4	0.04 - 0.20	0.1 - 1.5	8388374	
DNMG110408-FP5PDW WPP10G	0,8	0.08 - 0.25	0.2 - 2.0	8388375	
DNMG110408-FP5PDW WPP20G	0,8	0.08 - 0.25	0.2 - 2.0	8388376	
DNMG150404-FP5PDW WPP10G	0,4	0.05 - 0.20	0.1 - 1.5	8388377	
DNMG150404-FP5PDW WPP20G	0,4	0.05 - 0.20	0.1 - 1.5	8388378	
DNMG150408-FP5PDW WPP10G	0,8	0.08 - 0.25	0.2 - 2.0	8388379	
DNMG150408-FP5PDW WPP20G	0,8	0.08 - 0.25	0.2 - 2.0	8388380	
DNMG150604-FP5PDW WPP10G	0,4	0.05 - 0.20	0.1 - 1.5	8388381	
DNMG150604-FP5PDW WPP20G	0,4	0.05 - 0.20	0.1 - 1.5	8388382	
DNMG150608-FP5PDW WPP10G	0,8	0.08 - 0.25	0.2 - 2.0	8388383	
DNMG150608-FP5PDW WPP20G	0,8	0.08 - 0.25	0.2 - 2.0	8388384	
TNMG160404-FP5PDW WPP10G	0,4	0.04 - 0.20	0.1 - 1.5	8388385	
TNMG160404-FP5PDW WPP20G	0,4	0.04 - 0.20	0.1 - 1.5	8388386	
TNMG160408-FP5PDW WPP10G	0,8	0.08 - 0.25	0.2 - 2.0	8388387	
TNMG160408-FP5PDW WPP20G	0,8	0.08 - 0.25	0.2 - 2.0	8388388	
VNMG160404-FP5PDW WPP10G	0,4	0.04 - 0.22	0.1 - 1.5	8388389	
VNMG160404-FP5PDW WPP20G	0,4	0.04 - 0.22	0.1 - 1.5	8388390	
VNMG160408-FP5PDW WPP10G	0,8	0.08 - 0.25	0.2 - 2.0	8388391	
VNMG160408-FP5PDW WPP20G	0,8	0.08 - 0.25	0.2 - 2.0	8388392	
WNMG080404-FP5PDW WPP10G	0,4	0.05 - 0.20	0.1 - 1.5	8388393	
WNMG080404-FP5PDW WPP20G	0,4	0.05 - 0.20	0.1 - 1.5	8388394	
WNMG080408-FP5PDW WPP10G	0,8	0.08 - 0.25	0.2 - 2.0	8388395	
WNMG080408-FP5PDW WPP20G	0,8	0.08 - 0.25	0.2 - 2.0	8388396	

Sender

Company

Name

Building no. / street name

Town / postcode

Date

Signature

Use this form to fax your order now.

In collaboration with:

walter-tools.com

Order now and take advantage of the promotional discount!



	P	M	K	N	S	H	O
WPP10G	●●	●	●	●	●	●	●
WPP20G	●●	●	●	●	●	●	●
WPP30G	●●	●	●	●	●	●	●

Indexable insert

MP3 - Medium



Product description	r [mm]	f [mm]	a _p [mm]	SAP No.	Quantity
CNMG120404-MP3PDW WPP10G	0,4	0.08 - 0.22	0.3 - 2.5	8388397	
CNMG120404-MP3PDW WPP20G	0,4	0.08 - 0.22	0.3 - 2.5	8388398	
CNMG120408-MP3PDW WPP10G	0,8	0.12 - 0.32	0.6 - 3.2	8388399	
CNMG120408-MP3PDW WPP20G	0,8	0.12 - 0.32	0.6 - 3.2	8388400	
CNMG120412-MP3PDW WPP10G	1,2	0.16 - 0.40	0.8 - 3.5	8388401	
CNMG120412-MP3PDW WPP20G	1,2	0.16 - 0.40	0.8 - 3.5	8388402	
DNMG110404-MP3PDW WPP10G	0,4	0.08 - 0.22	0.3 - 2.2	8388403	
DNMG110404-MP3PDW WPP20G	0,4	0.08 - 0.22	0.3 - 2.2	8388404	
DNMG110408-MP3PDW WPP10G	0,8	0.12 - 0.32	0.6 - 3.0	8388405	
DNMG110408-MP3PDW WPP20G	0,8	0.12 - 0.32	0.6 - 3.0	8388406	
DNMG150604-MP3PDW WPP10G	0,4	0.08 - 0.22	0.3 - 2.5	8388407	
DNMG150604-MP3PDW WPP20G	0,4	0.08 - 0.22	0.3 - 2.5	8388408	
DNMG150608-MP3PDW WPP10G	0,8	0.12 - 0.32	0.6 - 3.2	8388409	
DNMG150608-MP3PDW WPP20G	0,8	0.12 - 0.32	0.6 - 3.2	8388410	
TNMG160404-MP3PDW WPP20G	0,4	0.08 - 0.22	0.3 - 2.2	8388411	
TNMG160408-MP3PDW WPP10G	0,8	0.12 - 0.32	0.6 - 3.0	8388412	
TNMG160408-MP3PDW WPP20G	0,8	0.12 - 0.32	0.6 - 3.0	8388413	
VNMG160404-MP3PDW WPP10G	0,4	0.08 - 0.22	0.3 - 2.2	8388414	
VNMG160404-MP3PDW WPP20G	0,4	0.08 - 0.22	0.3 - 2.2	8388415	
VNMG160408-MP3PDW WPP10G	0,8	0.12 - 0.32	0.6 - 3.0	8388416	
VNMG160408-MP3PDW WPP20G	0,8	0.12 - 0.32	0.6 - 3.0	8388417	

Sender

Company

Name

Building no. / street name

Town / postcode

Date

Signature

Use this form to fax your order now.

In collaboration with:

walter-tools.com

Order now and take advantage of the promotional discount!



	P	M	K	N	S	H	O
WPP10G	●●	●	●	●	●	●	●
WPP20G	●●	●	●	●	●	●	●
WPP30G	●●	●	●	●	●	●	●

Indexable insert

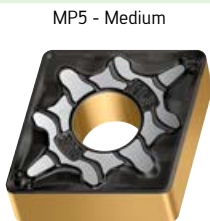

MP5 - Medium

Product description	r [mm]	f [mm]	a _p [mm]	SAP No.	Quantity
CNMG120404-MP5PDW WPP10G	0,4	0.16 - 0.25	0.5 - 4.0	8388418	
CNMG120404-MP5PDW WPP20G	0,4	0.16 - 0.25	0.5 - 4.0	8388419	
CNMG120408-MP5PDW WPP10G	0,8	0.18 - 0.40	0.6 - 5.0	8388420	
CNMG120408-MP5PDW WPP20G	0,8	0.18 - 0.40	0.6 - 5.0	8388421	
CNMG120408-MP5PDW WPP30G	0,8	0.18 - 0.40	0.6 - 5.0	8388422	
CNMG120412-MP5PDW WPP10G	1,2	0.20 - 0.45	1.0 - 5.0	8388423	
CNMG120412-MP5PDW WPP20G	1,2	0.20 - 0.45	1.0 - 5.0	8388424	
CNMG120412-MP5PDW WPP30G	1,2	0.20 - 0.45	1.0 - 5.0	8388425	
CNMG160608-MP5PDW WPP10G	0,8	0.25 - 0.40	0.8 - 7.0	8388426	
CNMG160608-MP5PDW WPP20G	0,8	0.25 - 0.40	0.8 - 7.0	8388427	
CNMG160612-MP5PDW WPP10G	1,2	0.30 - 0.50	1.0 - 7.0	8388428	
CNMG160612-MP5PDW WPP20G	1,2	0.30 - 0.50	1.0 - 7.0	8388429	
DNMG110408-MP5PDW WPP10G	0,8	0.18 - 0.35	0.6 - 4.0	8388430	
DNMG110408-MP5PDW WPP20G	0,8	0.18 - 0.35	0.6 - 4.0	8388431	
DNMG150408-MP5PDW WPP10G	0,8	0.18 - 0.35	0.6 - 5.0	8388432	
DNMG150408-MP5PDW WPP20G	0,8	0.18 - 0.35	0.6 - 5.0	8388433	
DNMG150604-MP5PDW WPP10G	0,4	0.16 - 0.25	0.5 - 4.0	8388434	
DNMG150604-MP5PDW WPP20G	0,4	0.16 - 0.25	0.5 - 4.0	8388435	
DNMG150608-MP5PDW WPP10G	0,8	0.18 - 0.35	0.6 - 5.0	8388436	
DNMG150608-MP5PDW WPP20G	0,8	0.18 - 0.35	0.6 - 5.0	8388437	
DNMG150612-MP5PDW WPP10G	1,2	0.20 - 0.40	1.0 - 5.0	8388438	
DNMG150612-MP5PDW WPP20G	1,2	0.20 - 0.40	1.0 - 5.0	8388439	
TNMG160404-MP5PDW WPP20G	0,4	0.16 - 0.25	0.5 - 4.0	8388440	
TNMG160408-MP5PDW WPP10G	0,8	0.18 - 0.35	0.6 - 4.0	8388441	
TNMG160408-MP5PDW WPP20G	0,8	0.18 - 0.35	0.6 - 4.0	8388442	
VNMG160404-MP5PDW WPP20G	0,4	0.10 - 0.18	0.5 - 2.0	8388443	
VNMG160408-MP5PDW WPP20G	0,8	0.18 - 0.35	0.6 - 4.0	8388444	
WNMG080404-MP5PDW WPP10G	0,4	0.16 - 0.25	0.5 - 4.0	8388445	
WNMG080404-MP5PDW WPP20G	0,4	0.16 - 0.25	0.5 - 4.0	8388446	
WNMG080408-MP5PDW WPP10G	0,8	0.18 - 0.40	0.6 - 5.0	8388447	
WNMG080408-MP5PDW WPP20G	0,8	0.18 - 0.40	0.6 - 5.0	8388448	
WNMG080408-MP5PDW WPP30G	0,8	0.18 - 0.40	0.6 - 5.0	8388449	
WNMG080412-MP5PDW WPP10G	1,2	0.20 - 0.45	1.0 - 5.0	8388450	
WNMG080412-MP5PDW WPP20G	1,2	0.20 - 0.45	1.0 - 5.0	8388451	
WNMG080412-MP5PDW WPP30G	1,2	0.20 - 0.45	1.0 - 5.0	8388452	

Sender

Company _____

Name _____

Building no. / street name _____

Town / postcode _____

Date _____ Signature _____

Use this form to fax your order now.

In collaboration with:

walter-tools.com

Order now and take advantage of the promotional discount!



	P	M	K	N	S	H	O
WPP10G	●●	●	●	●	●	●	●
WPP20G	●●	●	●	●	●	●	●
WPP30G	●●	●	●	●	●	●	●

Indexable insert

MU5 - Medium



Product description	r [mm]	f [mm]	a _p [mm]	SAP No.	Quantity
CNMG120408-MU5PDW WPP10G	0,8	0.15 - 0.40	0.6 - 5.0	8388453	
CNMG120408-MU5PDW WPP20G	0,8	0.15 - 0.40	0.6 - 5.0	8388454	
CNMG120412-MU5PDW WPP10G	1,2	0.20 - 0.50	1.0 - 5.0	8388455	
CNMG120412-MU5PDW WPP20G	1,2	0.20 - 0.50	1.0 - 5.0	8388456	
DNMG150608-MU5PDW WPP10G	0,8	0.18 - 0.35	0.6 - 5.0	8388457	
DNMG150608-MU5PDW WPP20G	0,8	0.18 - 0.35	0.6 - 5.0	8388458	
DNMG150612-MU5PDW WPP10G	1,2	0.20 - 0.45	1.0 - 5.0	8388459	
DNMG150612-MU5PDW WPP20G	1,2	0.20 - 0.45	1.0 - 5.0	8388460	
TNMG160404-MU5PDW WPP20G	0,4	0.15 - 0.30	0.5 - 4.0	8388461	
TNMG160408-MU5PDW WPP20G	0,8	0.18 - 0.35	0.6 - 4.0	8388462	
WNMG080408-MU5PDW WPP10G	0,8	0.15 - 0.40	0.6 - 5.0	8388463	
WNMG080408-MU5PDW WPP20G	0,8	0.15 - 0.40	0.6 - 5.0	8388464	
WNMG080412-MU5PDW WPP10G	1,2	0.20 - 0.50	1.0 - 5.0	8388465	
WNMG080412-MU5PDW WPP20G	1,2	0.20 - 0.50	1.0 - 5.0	8388466	

Sender

Company

Name

Building no. / street name

Town / postcode

Date

Signature

Use this form to fax your order now.

In collaboration with:

walter-tools.com

Order now and take advantage of the promotional discount!



	P	M	K	N	S	H	O
WPP10G	●●	●	●	●	●	●	●
WPP20G	●●	●	●	●	●	●	●
WPP30G	●●	●	●	●	●	●	●

Indexable insert



RP5 - Roughing

Product description	r [mm]	f [mm]	a _p [mm]	SAP No.	Quantity
CNMG120408-RP5PDW WPP10G	0,8	0.20 - 0.40	0.8 - 6.0	8388467	
CNMG120408-RP5PDW WPP20G	0,8	0.20 - 0.40	0.8 - 6.0	8388468	
CNMG120408-RP5PDW WPP30G	0,8	0.20 - 0.40	0.8 - 6.0	8388469	
CNMG120412-RP5PDW WPP10G	1,2	0.25 - 0.60	1.0 - 6.0	8388470	
CNMG120412-RP5PDW WPP20G	1,2	0.25 - 0.60	1.0 - 6.0	8388471	
CNMG120412-RP5PDW WPP30G	1,2	0.25 - 0.60	1.0 - 6.0	8388472	
CNMG160612-RP5PDW WPP10G	1,2	0.35 - 0.65	1.2 - 8.0	8388473	
CNMG160612-RP5PDW WPP20G	1,2	0.35 - 0.65	1.2 - 8.0	8388474	
CNMG160612-RP5PDW WPP30G	1,2	0.35 - 0.65	1.2 - 8.0	8388475	
CNMG160616-RP5PDW WPP10G	1,6	0.40 - 0.70	1.6 - 8.0	8388476	
CNMG160616-RP5PDW WPP20G	1,6	0.40 - 0.70	1.6 - 8.0	8388477	
CNMG190612-RP5PDW WPP20G	1,2	0.30 - 0.70	1.2 - 10.	8386253	
CNMG190612-RP5PDW WPP30G	1,2	0.30 - 0.70	1.2 - 10.	8386254	
CNMG190616-RP5PDW WPP20G	1,6	0.35 - 0.80	1.6 - 10.	8386255	
CNMG190616-RP5PDW WPP30G	1,6	0.35 - 0.80	1.6 - 10.	8386256	
DNMG150608-RP5PDW WPP10G	0,8	0.15 - 0.35	0.8 - 5.0	8388478	
DNMG150608-RP5PDW WPP20G	0,8	0.15 - 0.35	0.8 - 5.0	8388479	
DNMG150608-RP5PDW WPP30G	0,8	0.15 - 0.35	0.8 - 5.0	8388480	
DNMG150612-RP5PDW WPP10G	1,2	0.20 - 0.55	1.0 - 5.0	8388481	
DNMG150612-RP5PDW WPP20G	1,2	0.20 - 0.55	1.0 - 5.0	8388482	
WNMG080408-RP5PDW WPP10G	0,8	0.20 - 0.40	0.8 - 6.0	8388483	
WNMG080408-RP5PDW WPP20G	0,8	0.20 - 0.40	0.8 - 6.0	8388484	
WNMG080408-RP5PDW WPP30G	0,8	0.20 - 0.40	0.8 - 6.0	8388485	
WNMG080412-RP5PDW WPP10G	1,2	0.25 - 0.60	1.0 - 6.0	8388486	
WNMG080412-RP5PDW WPP20G	1,2	0.25 - 0.60	1.0 - 6.0	8388487	
WNMG080412-RP5PDW WPP30G	1,2	0.25 - 0.60	1.0 - 6.0	8388488	



RP7 - Roughing

CNMG120408-RP7PDW WPP10G	0,8	0.18 - 0.40	0.8 - 5.0	8388489	
CNMG120408-RP7PDW WPP20G	0,8	0.18 - 0.40	0.8 - 5.0	8388490	
CNMG120408-RP7PDW WPP30G	0,8	0.18 - 0.40	0.8 - 5.0	8388491	
CNMG120412-RP7PDW WPP10G	1,2	0.25 - 0.50	1.2 - 5.0	8388492	
CNMG120412-RP7PDW WPP20G	1,2	0.25 - 0.50	1.2 - 5.0	8388493	
CNMG120412-RP7PDW WPP30G	1,2	0.25 - 0.50	1.2 - 5.0	8388494	
CNMG160612-RP7PDW WPP10G	1,2	0.35 - 0.60	1.2 - 6.0	8388495	
CNMG160612-RP7PDW WPP20G	1,2	0.35 - 0.60	1.2 - 6.0	8388496	
CNMG160612-RP7PDW WPP30G	1,2	0.35 - 0.60	1.2 - 6.0	8388497	

Sender

Company _____

Name _____

Building no. / street name _____

Town / postcode _____

Date _____ Signature _____

Use this form to fax your order now.

In collaboration with:

walter-tools.com

Order now and take advantage of the promotional discount!



	P	M	K	N	S	H	O
WPP10G	●●	●	●	●	●	●	●
WPP20G	●●	●	●	●	●	●	●
WPP30G	●●	●	●	●	●	●	●

Indexable insert

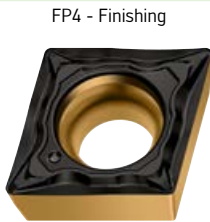

FP4 - Finishing

Product description	r [mm]	f [mm]	a _p [mm]	SAP No.	Quantity
CCMT060202-FP4PDW WPP10G	0,2	0.04 - 0.12	0.1 - 1.0	8387652	
CCMT060202-FP4PDW WPP20G	0,2	0.04 - 0.12	0.1 - 1.0	8387653	
CCMT060204-FP4PDW WPP10G	0,4	0.05 - 0.16	0.1 - 1.5	8387655	
CCMT060204-FP4PDW WPP20G	0,4	0.05 - 0.16	0.1 - 1.5	8387654	
CCMT09T304-FP4PDW WPP10G	0,4	0.05 - 0.16	0.1 - 1.5	8387664	
CCMT09T304-FP4PDW WPP20G	0,4	0.05 - 0.16	0.1 - 1.5	8387663	
CCMT09T308-FP4PDW WPP10G	0,8	0.08 - 0.20	0.1 - 1.5	8387670	
CCMT09T308-FP4PDW WPP20G	0,8	0.08 - 0.20	0.1 - 1.5	8387669	
DCMT070204-FP4PDW WPP10G	0,4	0.05 - 0.16	0.1 - 1.5	8387682	
DCMT070204-FP4PDW WPP20G	0,4	0.05 - 0.16	0.1 - 1.5	8387681	
DCMT11T302-FP4PDW WPP10G	0,2	0.04 - 0.12	0.1 - 1.0	8387684	
DCMT11T302-FP4PDW WPP20G	0,2	0.04 - 0.12	0.1 - 1.0	8387683	
DCMT11T304-FP4PDW WPP10G	0,4	0.05 - 0.16	0.1 - 1.5	8387685	
DCMT11T304-FP4PDW WPP20G	0,4	0.05 - 0.16	0.1 - 1.5	8387650	
DCMT11T308-FP4PDW WPP10G	0,8	0.08 - 0.20	0.1 - 1.5	8387691	
DCMT11T308-FP4PDW WPP20G	0,8	0.08 - 0.20	0.1 - 1.5	8387692	
TCMT06T102-FP4PDW WPP20G	0,2	0.02 - 0.10	0.1 - 1.0	8387715	
TCMT06T104-FP4PDW WPP20G	0,4	0.04 - 0.17	0.1 - 1.0	8387716	
TCMT110202-FP4PDW WPP20G	0,2	0.04 - 0.12	0.1 - 1.0	8387717	
TCMT110204-FP4PDW WPP10G	0,4	0.05 - 0.16	0.1 - 1.5	8387718	
TCMT110204-FP4PDW WPP20G	0,4	0.05 - 0.16	0.1 - 1.5	8387719	
VCMT110302-FP4PDW WPP20G	0,2	0.04 - 0.12	0.1 - 1.0	8387702	
VCMT110304-FP4PDW WPP10G	0,4	0.05 - 0.16	0.1 - 1.5	8387703	
VCMT110304-FP4PDW WPP20G	0,4	0.05 - 0.16	0.1 - 1.5	8387704	
VCMT160402-FP4PDW WPP20G	0,2	0.04 - 0.12	0.1 - 1.0	8387707	
VCMT160404-FP4PDW WPP10G	0,4	0.05 - 0.16	0.1 - 1.5	8387709	
VCMT160404-FP4PDW WPP20G	0,4	0.05 - 0.16	0.1 - 1.5	8387708	
VCMT160408-FP4PDW WPP10G	0,8	0.08 - 0.20	0.1 - 1.5	8387712	
VCMT160408-FP4PDW WPP20G	0,8	0.08 - 0.20	0.1 - 1.5	8387651	

Sender

Company _____

Name _____

Building no. / street name _____

Town / postcode _____

Date _____ Signature _____

Use this form to fax your order now.

In collaboration with: _____

walter-tools.com

Order now and take advantage of the promotional discount!



	P	M	K	N	S	H	O
WPP10G	●●	●	●	●	●	●	●
WPP20G	●●	●	●	●	●	●	●
WPP30G	●●	●	●	●	●	●	●

Indexable insert

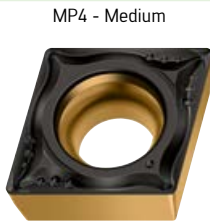

MP4 - Medium

Product description	r [mm]	f [mm]	a _p [mm]	SAP No.	Quantity
CCMT060204-MP4PDW WPP10G	0,4	0.08 - 0.20	0.4 - 2.0	8387657	
CCMT060204-MP4PDW WPP20G	0,4	0.08 - 0.20	0.4 - 2.0	8387656	
CCMT060208-MP4PDW WPP20G	0,8	0.12 - 0.25	0.5 - 2.0	8387660	
CCMT09T304-MP4PDW WPP10G	0,4	0.08 - 0.25	0.4 - 3.0	8387666	
CCMT09T304-MP4PDW WPP20G	0,4	0.08 - 0.25	0.4 - 3.0	8387665	
CCMT09T308-MP4PDW WPP10G	0,8	0.12 - 0.32	0.5 - 3.0	8387671	
CCMT09T308-MP4PDW WPP20G	0,8	0.12 - 0.32	0.5 - 3.0	8386258	
CCMT120404-MP4PDW WPP20G	0,4	0.12 - 0.25	0.4 - 3.5	8387675	
CCMT120408-MP4PDW WPP20G	0,8	0.12 - 0.32	0.5 - 3.5	8387678	
DCMT11T304-MP4PDW WPP10G	0,4	0.08 - 0.25	0.4 - 3.0	8387687	
DCMT11T304-MP4PDW WPP20G	0,4	0.08 - 0.25	0.4 - 3.0	8387686	
DCMT11T308-MP4PDW WPP10G	0,8	0.12 - 0.32	0.5 - 3.0	8387694	
DCMT11T308-MP4PDW WPP20G	0,8	0.12 - 0.32	0.5 - 3.0	8387693	
TCMT110204-MP4PDW WPP20G	0,4	0.08 - 0.20	0.4 - 2.0	8387720	
TCMT16T304-MP4PDW WPP20G	0,4	0.08 - 0.25	0.4 - 3.0	8387721	
TCMT16T308-MP4PDW WPP20G	0,8	0.12 - 0.32	0.5 - 3.0	8387724	
VBMT160404-MP4PDW WPP10G	0,4	0.08 - 0.20	0.4 - 2.0	8387699	
VBMT160404-MP4PDW WPP20G	0,4	0.08 - 0.20	0.4 - 2.0	8387698	
VBMT160408-MP4PDW WPP10G	0,8	0.12 - 0.30	0.5 - 2.0	8387700	
VBMT160408-MP4PDW WPP20G	0,8	0.12 - 0.30	0.5 - 2.0	8387701	

Sender

Company

Name

Building no. / street name

Town / postcode

Date

Signature

Use this form to fax your order now.

In collaboration with:

walter-tools.com

Order now and take advantage of the promotional discount!



	P	M	K	N	S	H	O
WPP10G	●●	●	●	●	●	●	●
WPP20G	●●	●	●	●	●	●	●
WPP30G	●●	●	●	●	●	●	●

Indexable insert

RP4 - Roughing

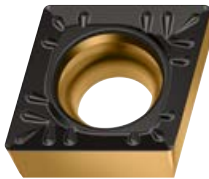

Product description	r [mm]	f [mm]	a _p [mm]	SAP No.	Quantity
CCMT060204-RP4PDW WPP20G	0,4	0.12 - 0.25	0.4 - 2.5	8387658	
CCMT060204-RP4PDW WPP30G	0,4	0.12 - 0.25	0.4 - 2.5	8387659	
CCMT060208-RP4PDW WPP20G	0,8	0.16 - 0.30	0.6 - 2.5	8387662	
CCMT060208-RP4PDW WPP30G	0,8	0.16 - 0.30	0.6 - 2.5	8387661	
CCMT09T304-RP4PDW WPP10G	0,4	0.12 - 0.25	0.4 - 3.0	8387668	
CCMT09T304-RP4PDW WPP20G	0,4	0.12 - 0.25	0.4 - 3.0	8387667	
CCMT09T304-RP4PDW WPP30G	0,4	0.12 - 0.25	0.4 - 3.0	8386257	
CCMT09T308-RP4PDW WPP10G	0,8	0.16 - 0.35	0.6 - 4.0	8387674	
CCMT09T308-RP4PDW WPP20G	0,8	0.16 - 0.35	0.6 - 4.0	8387673	
CCMT09T308-RP4PDW WPP30G	0,8	0.16 - 0.35	0.6 - 4.0	8387672	
CCMT120404-RP4PDW WPP20G	0,4	0.12 - 0.30	0.4 - 4.0	8387677	
CCMT120404-RP4PDW WPP30G	0,4	0.12 - 0.30	0.4 - 4.0	8387676	
CCMT120408-RP4PDW WPP10G	0,8	0.16 - 0.40	0.6 - 5.0	8387680	
CCMT120408-RP4PDW WPP20G	0,8	0.16 - 0.40	0.6 - 5.0	8386259	
CCMT120408-RP4PDW WPP30G	0,8	0.16 - 0.40	0.6 - 5.0	8387679	
DCMT11T304-RP4PDW WPP10G	0,4	0.12 - 0.25	0.4 - 3.0	8387690	
DCMT11T304-RP4PDW WPP20G	0,4	0.12 - 0.25	0.4 - 3.0	8387688	
DCMT11T304-RP4PDW WPP30G	0,4	0.12 - 0.25	0.4 - 3.0	8387689	
DCMT11T308-RP4PDW WPP10G	0,8	0.16 - 0.35	0.6 - 4.0	8387697	
DCMT11T308-RP4PDW WPP20G	0,8	0.16 - 0.35	0.6 - 4.0	8387695	
DCMT11T308-RP4PDW WPP30G	0,8	0.16 - 0.35	0.6 - 4.0	8387696	
SCMT09T304-RP4PDW WPP20G	0,4	0.12 - 0.25	0.4 - 3.0	8387727	
SCMT09T304-RP4PDW WPP30G	0,4	0.12 - 0.25	0.4 - 3.0	8387728	
SCMT09T308-RP4PDW WPP20G	0,8	0.16 - 0.35	0.6 - 4.0	8387729	
SCMT09T308-RP4PDW WPP30G	0,8	0.16 - 0.35	0.6 - 4.0	8387730	
SCMT120408-RP4PDW WPP20G	0,8	0.16 - 0.40	0.6 - 5.0	8387731	
SCMT120408-RP4PDW WPP30G	0,8	0.16 - 0.40	0.6 - 5.0	8387732	
TCMT16T304-RP4PDW WPP20G	0,4	0.12 - 0.25	0.4 - 3.0	8387722	
TCMT16T304-RP4PDW WPP30G	0,4	0.12 - 0.25	0.4 - 3.0	8387723	
TCMT16T308-RP4PDW WPP20G	0,8	0.16 - 0.35	0.6 - 4.0	8387725	
TCMT16T308-RP4PDW WPP30G	0,8	0.16 - 0.35	0.6 - 4.0	8387726	
VCMT110304-RP4PDW WPP20G	0,4	0.12 - 0.20	0.4 - 2.5	8387705	
VCMT110308-RP4PDW WPP20G	0,8	0.16 - 0.25	0.6 - 3.0	8387706	
VCMT160404-RP4PDW WPP10G	0,4	0.12 - 0.25	0.4 - 2.5	8387711	
VCMT160404-RP4PDW WPP20G	0,4	0.12 - 0.25	0.4 - 2.5	8387710	
VCMT160408-RP4PDW WPP10G	0,8	0.16 - 0.30	0.6 - 3.0	8387713	
VCMT160408-RP4PDW WPP20G	0,8	0.16 - 0.30	0.6 - 3.0	8387714	

Sender

Company _____

Name _____

Building no. / street name _____

Town / postcode _____

Date _____ Signature _____

Use this form to fax your order now.

In collaboration with: _____

walter-tools.com

Camcut Oy
www.camcut.fi
myynti@camcut.fi
+358 45 1872 212

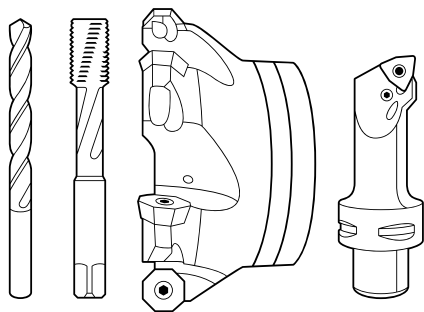

www.walter-tools.com