



_ WALTER BLAXX: THE NEW GENERATION OF MILLING CUTTERS

Powerful, precise, reliable.

Product innovations

Milling

New:
Expanded
product range



Walter BLAXX
powered by Tiger-tec® Silver



UNBEATABLE COMBINATION: WALTER BLAXX AND TIGER-TEC® SILVER.



Walter BLAXX

Maximise tool life and precision.

Anyone who wants to optimise the performance of their production must take all parameters into consideration. Doing so brings into focus one of the most striking aspects of the process chain: Because the point where tool and work-piece meet is where it becomes clear whether the desired product quality can actually be achieved.

Tiger-tec® Silver

What is required is a reliable system which facilitates absolute precision and stands out thanks to its extremely long tool life. The Walter BLAXX milling cutters impress with their incredibly robust tool bodies. These are equipped with Walter's most efficient indexable inserts – powered by Tiger-tec® Silver.

A system that can be relied on – and which gives innovative companies the opportunity to make the most of their true strengths: Developing and manufacturing impressive products.

LNHU130608R-L55T tangential indexable inserts

Four useable, precisely 90° cutting edges

Protected against wear by special surface treatment

Positive cutting characteristics

F5141 shoulder mill,
80 mm diameter



Powered by
Tiger-tec® Silver



Walter BLAXX

The benchmark for a new generation of milling cutters.

The new Walter BLAXX generation of milling cutters combines two factors that are crucial for productivity, process reliability and precision: The extremely robust Walter BLAXX mill bodies and the best indexable inserts in the Walter range – powered by Tiger-tec® Silver. A system with impressive properties, that has long been sought after on the market by demanding cutting machine tool operators:

- The tool body has extra protection against wear thanks to a special surface treatment
- Walter BLAXX is the first milling system to combine the benefits of tangential milling systems with the unbeatable performance data of Tiger-tec® Silver indexable inserts
- With four cutting edges per indexable insert, a precise angle of 90° at the workpiece and an incredibly robust body, Walter BLAXX has set new standards in terms of productivity and process reliability in shoulder milling

POWER AND PRECISION YOU CAN RELY ON.



Powerful cut thanks to the high volume of carbide in the direction of the cutting force F_c



Maximum rigidity thanks to the large material cross-section in the mill body

The tangential revolution from Walter.

The Walter BLAXX mission: Being able to take advantage of all the benefits of tangential milling systems under the very conditions where radial strategies come up against their physical limits, without having to forgo the performance data of the Tiger-tec® Silver indexable inserts.

Wherever you need a tangential system, Walter BLAXX is the solution. For years, Walter has stood for exactly what the new generation of milling cutters realises: Assuring that the entire process chain of production is organised more efficiently over the long term, starting with the tool itself.

Comparison: Feed rate per tooth f_z [mm]

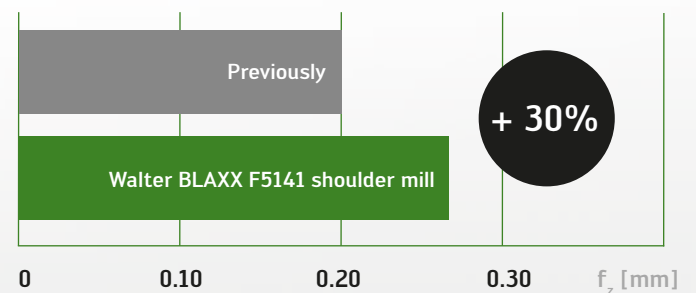

Full effective version

Internal coolant supply at every cutting edge

LNHU1306 system indexable insert

Wear-protected body



F5138 porcupine cutter, 80 mm diameter with LNHU1306 . .

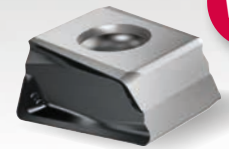

L65T geometry for machining stainless steels and titanium – powered by Tiger-tec® Silver



L55T geometry for universal use – powered by Tiger-tec® Silver

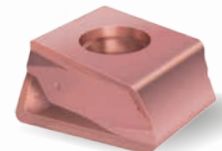

L85T geometry for aluminium machining



F5138 porcupine cutter, 40 mm diameter with LNHU1306 . .



F5241 shoulder mill, 63 mm diameter with LNHU1607 . .



F5038 porcupine cutter, 25 mm diameter with LNHU0904 . .

Walter BLAXX

Take advantage of the power of a tangential system.

The benefits of a tangential milling system are only fully effective under conditions where all parameters are perfectly matched together. With Walter BLAXX, not only is the most powerful of Walter tool bodies now available, but Tiger-tec® Silver indexable inserts can also be used as part of a tangential system.

In addition, three new PVD-coated grades have been introduced for the first time: WKK25S, WSM35S and WSP45S. This means that the milling system can be used on almost all materials.

The result is an impressive + 30% increase in feed rate per tooth.

When the feed rate per tooth of a tangential Walter BLAXX shoulder mill is compared with that of a radial shoulder mill, the increase is up to 30%. This is due to the exactly matched interplay between the new, tangential Tiger-tec® Silver indexable inserts and the Walter BLAXX tool bodies.

Surprisingly versatile: Equipped with L85T geometries, Walter BLAXX also makes the most of its strengths in aluminium machining.

WHERE PERFORMANCE IS ESSENTIAL!



LNMX201012 system indexable insert can be used for all approach angles

4 cutting edges per indexable insert

Tangential cutting edge arrangement

Stop piece with emergency cutting function



Heavy-duty M3016 cutter, 160 mm diameter, $\kappa = 60^\circ$ with LNMX201012 system indexable insert.

Maximum productivity and process reliability.

The new Walter BLAXX M3016 60° heavy-duty cutters impress across the entire wide range of applications. The tangentially arranged indexable inserts, supported by carbide stop pieces with emergency cutting function, as well as the special tool body surface treatment are crucial to the cutter's performance.

With four cutting edges per indexable insert, the milling cutter can cut to depths of up to 16 mm, has a particularly soft cutting action and maximum machining volumes when face milling steel and cast iron materials. A heavy-duty cutter with an approach angle of 15° or 90° is available on request via Walter Xpress.

High level of cost efficiency

- Maximum machining volume
- Low cutting material costs due to four cutting edges per indexable insert

High process reliability

- Stable, tangential indexable inserts
- Emergency cutting function of the stop piece protects the body in the event of an insert fracture

Powered by Tiger-tec® Silver

- Two CVD-coated grades (WKP25S and WKP35S) and two PVD-coated grades (WKK25S and WSP45S) for steel and cast iron

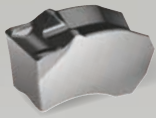

SX indexable insert for separating and slitting – powered by Tiger-tec® Silver



CE4 –
The stable one



SF5 –
The universal one

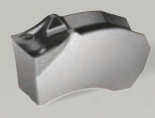

CF6 –
The easy-cutting one

Three SX indexable inserts for separating and slitting: With specially designed geometries for a wide variety of different machining conditions – powered by Tiger-tec® Silver

The machining force is introduced into the rigid section of the insert seat

Top clamp with extremely high retaining forces

Tiger-tec® Silver cutting tool materials with maximum productivity



F5055 slitting cutter, 160 mm diameter with SX-4E00N02 . .



F5055 slitting cutter, 125 mm diameter with SX-3E300N02 . .

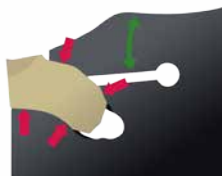

Extremely high retaining forces as a result of the optimised top clamp; the cutting forces are absorbed in the rigid section of the tool.

Keep control when separating and slitting.

The Walter BLAXX F5055 slitting cutter wins over with its process reliability and high level of radial and axial runout accuracy. This is ensured firstly by the incredibly high retaining forces of the optimally shaped top clamp, and secondly by the extreme stability of the F5055, which results from the machining force being introduced into the rigid section of the insert seat. This, along with the easy-to-use self-clamping system and the high productivity of Tiger-tec® Silver cutting tool materials, places the F5055 in a class of its own.

Maximum process reliability

- Extremely high retaining forces as a result of the optimised top clamp
- Positive and self-locking cutting insert clamping system
- Machining force is introduced into the rigid part of the insert seat

Low inventory costs

- System indexable inserts, suitable for use in slitting cutters and groove turning holders

Powered by Tiger-tec® Silver

- One CVD-coated grade (WKP23S) for cast iron materials and two PVD-coated grades (WSM33S and WSP43S) for steel, stainless steels and difficult-to-machine materials

COST-EFFICIENT, WITH PROCESS RELIABILITY.



M3024 heptagon milling cutter, 63 mm diameter with XN.U0705ANN... or XNMU070508...

New

Version with facet or corner radius

14 cutting edges per indexable insert

As reliable as it is cost-efficient.

The Walter BLAXX M3024 45° face milling cutter is extremely cost-efficient and offers process reliability at the same time: The heptagon milling cutter impresses not only with its 14 cutting edges per indexable insert, but also its carbide shims which facilitate very high feed rates per tooth. Maximum cutting depths of up to 4 mm and a soft cutting action are no problem for this tool, thanks to positive cutting edge geometry.

High level of cost efficiency

- High machining volume, even on low-performance machines, due to positive, soft cutting action
- Low cutting material costs due to 14 cutting edges per indexable insert

High process reliability

- Stable, negative indexable inserts
- Optimum contact area due to carbide shim

Powered by Tiger-tec® Silver

- Two CVD-coated grades (WKP25S and WKP35S) for steel and cast iron, and three PVD-coated grades (WKK25S, WSM35S and WSP45S) for steel, cast iron and stainless steels

Walter AG

Derendinger Str. 53, 72072 Tübingen
Postfach 2049, 72010 Tübingen
Germany

www.walter-tools.com

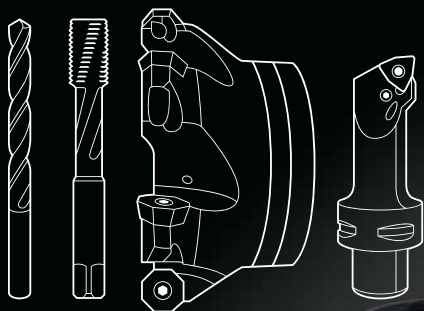

Walter GB Ltd.

Bromsgrove, England
+44 (1527) 839 450, service.uk@walter-tools.com

Walter Kesici Takımlar Sanayi ve Ticaret Ltd. Şti.

Istanbul, Türkiye
+90 (216) 528 1900 Pbx, service.tr@walter-tools.com

Walter Wuxi Co. Ltd.

Wuxi, Jiangsu, P.R. China
+86 (510) 8537 2199, service.cn@walter-tools.com

Walter AG Singapore Pte. Ltd.

+65 6773 6180, service.sg@walter-tools.com

Walter Korea Ltd.

Anyang-si Gyeonggi-do, Korea
+82 (31) 337 6100, service.kr@walter-tools.com

Walter Tools India Pvt. Ltd.

Pune, India
+91 (20) 3045 7300, service.in@walter-tools.com

Walter (Thailand) Co., Ltd.

Bangkok, 10120, Thailand
+66 2 687 0388, service.th@walter-tools.com

Walter Malaysia Sdn. Bhd.

Selangor D.E., Malaysia
+60 (3) 8023 7748, service.my@walter-tools.com

Walter Japan K.K.

Nagoya, Japan
+81 (52) 533 6135, service.jp@walter-tools.com

Walter USA, LLC

Waukesha WI, USA
+1 800-945-5554, service.us@walter-tools.com

Walter Canada

Mississauga, Canada
service.ca@walter-tools.com

