

MU5 Geometry Product Description

Product
Description

Positive macro-geometry and open chip groove design
For highest tool life

New V-chip former design
For best chip breakage

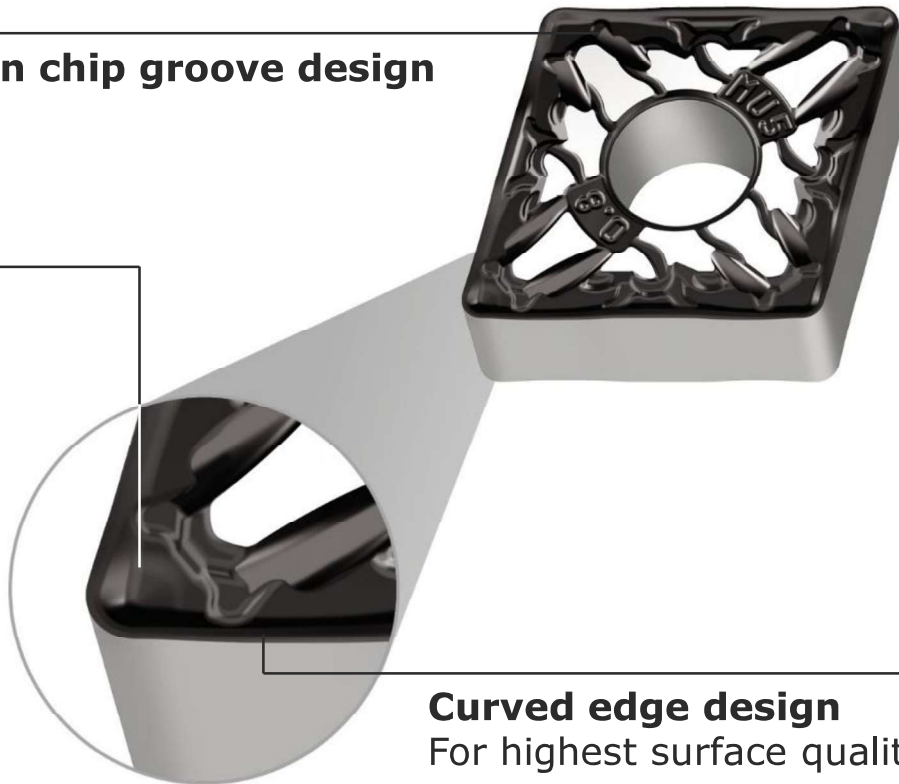

Curved edge design
For highest surface quality in Copy Turning

MU5 Geometry Product Description

Product
Description

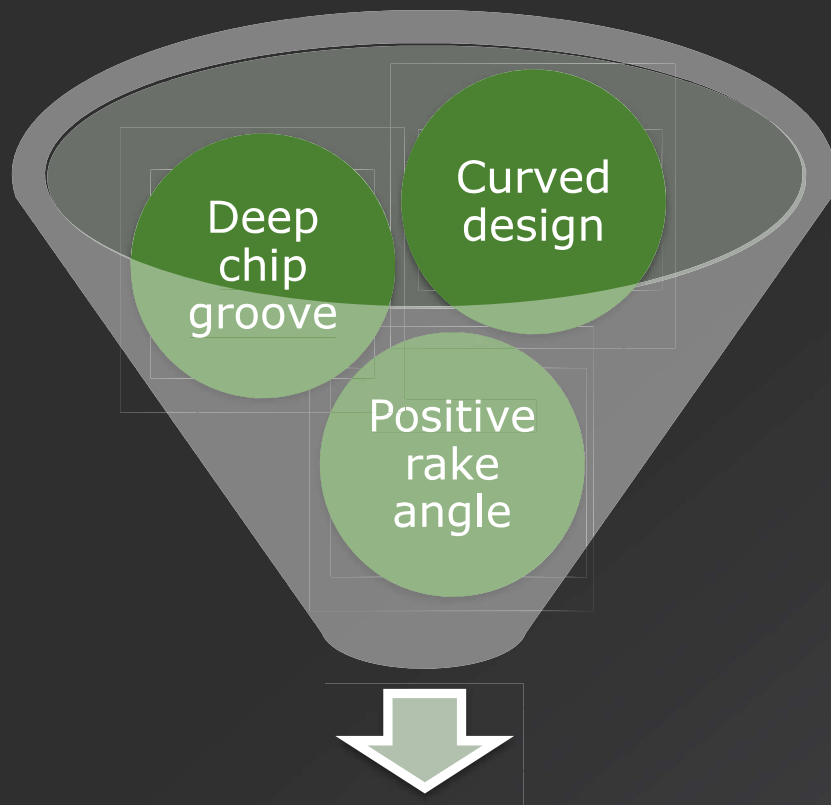

ISO P & ISO M

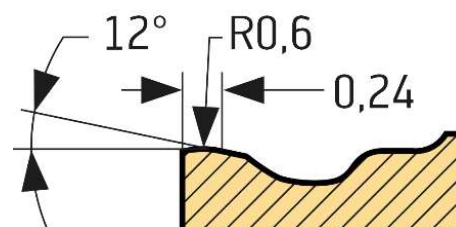

Main cutting edge

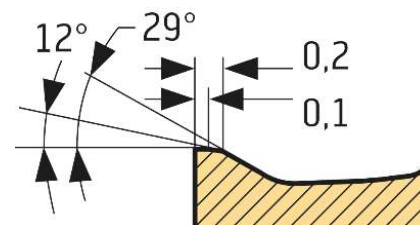

Corner radius

MU5 Geometry Product Description

Product Description

P

Medium
MP5

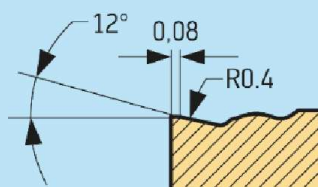

Medium
MU5

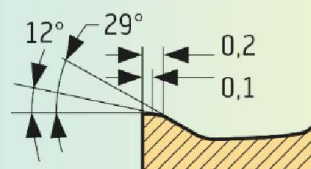

Medium
MM5

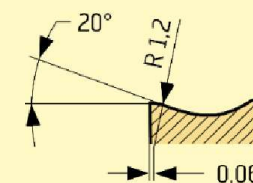

M

← **stable**

sharp →